

**MYDRIAZ**  
PARIS

LIGHTNING AND FURNITURE DESIGN



**Mydriaz Paris** is a lighting and decorative furniture design studio established in 2011. In the studio under the Viaduc des Arts, Jennifer Midoz and her team carry out large-scale projects, from the first sketch to production and installation. The pieces, all hand-crafted, can be found in prestigious boutiques, hotels and private apartments. Mydriaz exports its creations to the four corners of the world, catering to an international clientele. For over 10 years, Mydriaz's vision has seduced leading luxury houses, architects and decorators.

**Jennifer Midoz** is a graduate of the Ecole Boulle. After starting out in museography, she created her first brand as a jewelry designer. At the time, Jennifer was inspired by the pure, architectural forms of the Bauhaus, and the sculptures of Eduardo Chillida and Louise Bourgeois. Her passion? Playing with textures that catch the light... Perhaps this is what predestined her for the second stage of her career: the co-creation of the Mydriaz studio, where light plays a fundamental role.

The following products are intended to be customised and assembled into compositions.

**OBLONG**



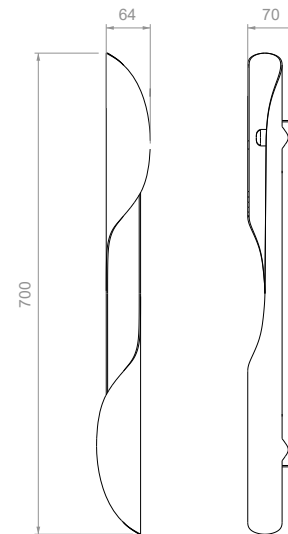
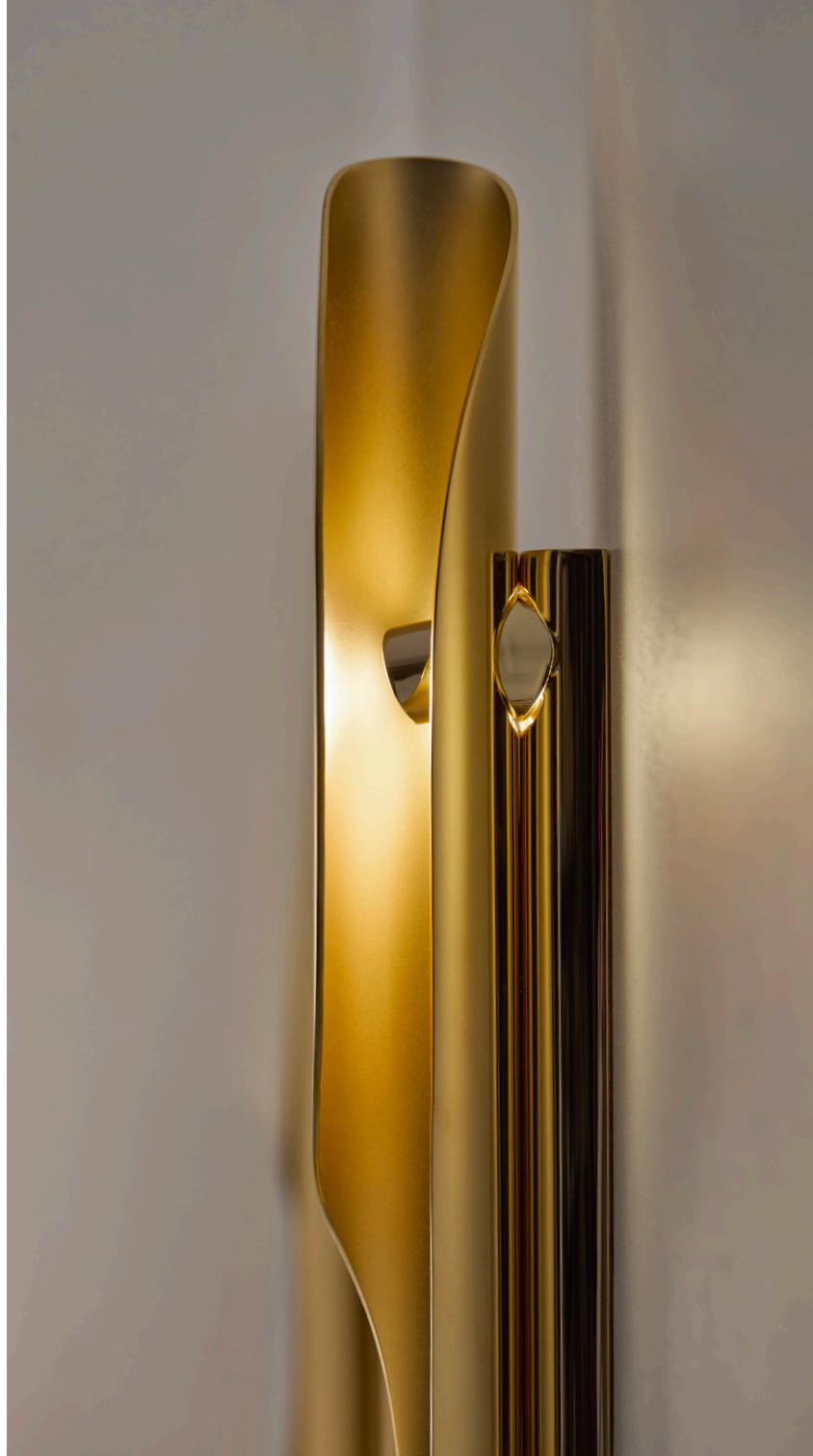



## TORSADE

---

### MATERIALS

Brass

### FINISHES

-  Polished pale gold
-  Polished white nickel
-  Polished black nickel

### LIGHT SOURCE

12V to 54V LED spotlights 6W - 700mA,  
dimmable, class 3

Driver necessary

CE certification or US wired, all components are  
UL listed, UL Certification on request.



### DIMENSIONS & WEIGHT\*

H 700 x W 64 x D 70 mm, 2 kg

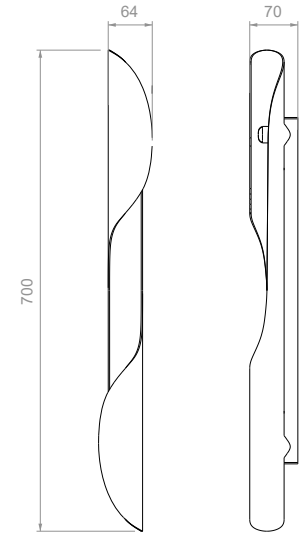



## TORSADE CÉRAMIQUE

### MATERIALS

Ceramic and brass

### FINISHES

-  Glazed ceramic (various colors)
-  Polished pale gold
-  Polished white nickel

### LIGHT SOURCE

12V to 54V LED spotlights 6W - 700mA, dimmable, class 3

Driver necessary

CE certification or US wired, all components are UL listed, UL Certification on request.



### DIMENSIONS & WEIGHT\*

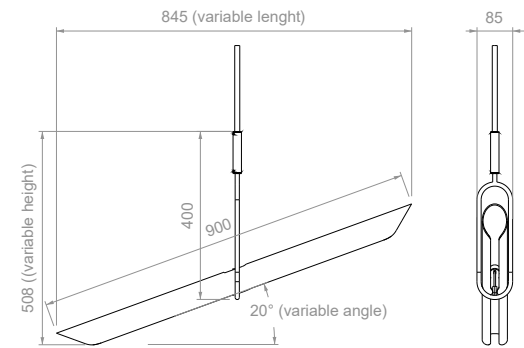

H 700 x W 64 x D 70 mm, 2 kg



## CALAME

MATERIALS  
Brass

### FINISHES

-  Polished pale gold
-  Polished white nickel
-  Polished black nickel

### LIGHT SOURCE

24V LED strip, 18 Watts, dimmable, class 3 

Driver necessary

CE certification or US wired, all components are UL listed, UL Certification on request.

DIMENSIONS & WEIGHT\*  
H 508 x W 85 x L 845 mm, 3 kg

COLD LIGHT exhibition by Mydriaz for Paris Design Week 2024.  
*Calame* pendant, *Mercure* wall lights, *Dorique* armchair, *Tag* tiles,  
*Arc* coffee table, *Sgraffito* table lamp, *Glaieul* floor lamp.



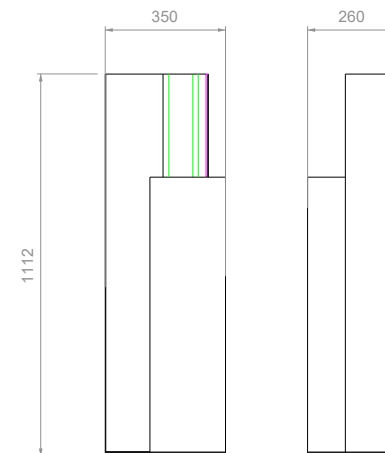



## ECHO

MATERIALS  
Brass

### FINISHES

 Raw brass

 Colored varnish  
(various colors)

LIGHT SOURCE  
24V LED strip, 18 Watts, dimmable, class 3   
Integrated driver  
CE certification or US wired, all components are  
UL listed, UL Certification on request.

DIMENSIONS & WEIGHT\*  
H 1112 x W 260 x L 350 mm, 10 kg



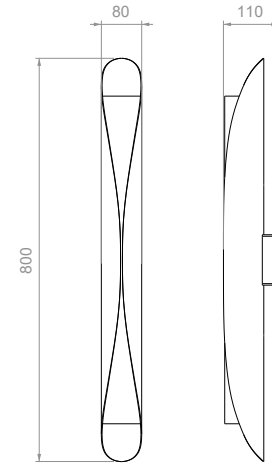



## COCON

### MATERIALS

Brass and lacquered glass

### FINISHES

-  Polished pale gold
-  Polished white nickel
-  Polished black nickel

### LIGHT SOURCE

24V LED strip, 18 Watts, dimmable, class 3   
Driver necessary  
CE certification or US wired, all components are  
UL listed, UL Certification on request.

### DIMENSIONS & WEIGHT\*

H 800 x Ø80 x D 110 mm, 5 kg



L



S



M1

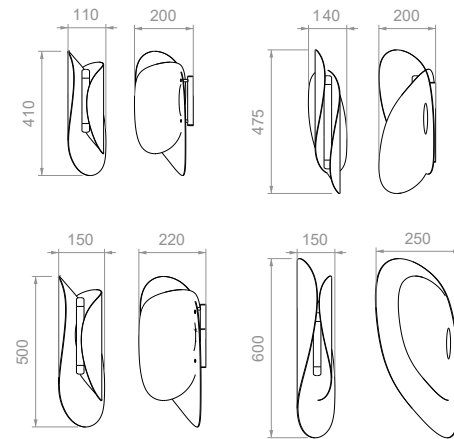

## DUNE

**MATERIALS**  
Brass

**FINISHES**

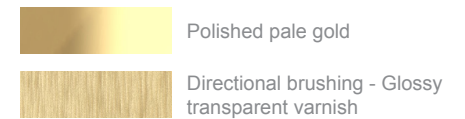

**LIGHT SOURCE**  
24V LED strip, 4 to 8 Watts, dimmable, class 3  
Driver necessary  
CE certification or US wired, all components are  
UL listed, UL Certification on request.

**DIMENSIONS & WEIGHT\***  
S : H 410 x W 110 x D 200 mm, 4 kg  
M1 : H 475 x W 140 x D 200 mm, 5 kg  
M2 : H 500 x W 150 x D 220 mm, 5 kg  
L : H 600 x W 150 x D 250 mm, 6 kg

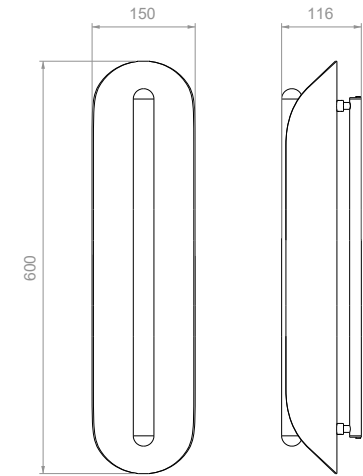
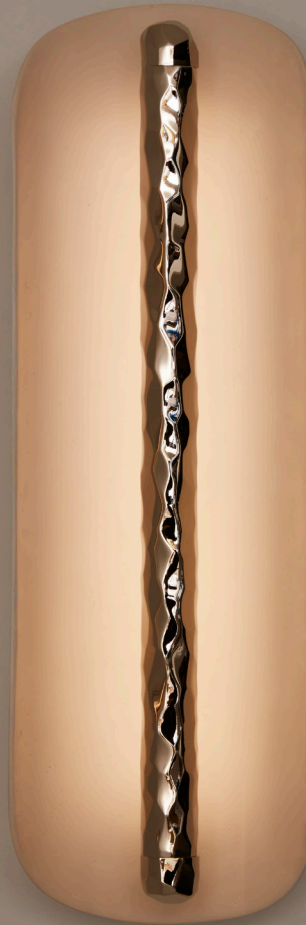

## SILEX

**MATERIALS**  
Brass

### FINISHES

Left



Polished pale gold

Middle



Polished pale gold



Directional brushing -  
Glossy transparent varnish

Right



Polished white nickel



Porcelain bisque finish

### LIGHT SOURCE

24V LED strip, 12 Watts, dimmable, class 3   
Driver necessary  
CE certification or US wired, all components are  
UL listed, UL Certification on request.

**DIMENSIONS & WEIGHT\***  
H 600 x W 150 x D 116 mm, 8 kg

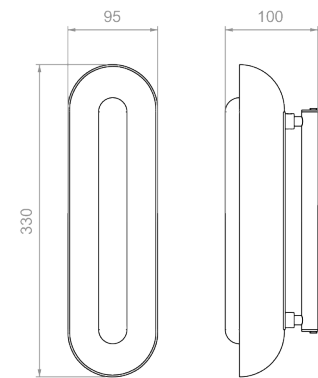

## COSMOS CÉRAMIQUE

### MATERIALS

Brass and ceramic

### FINISHES

#### Left

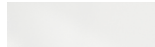
 Glazed ceramic (various colors)

 Black nickel

#### Middle

 Glazed ceramic (various colors)

 Black patina

#### Right

 Glazed ceramic (various colors)

 White nickel

### LIGHT SOURCE

24V LED strip, 5 Watts, dimmable, class 3 

Driver necessary

CE certification or US wired, all components are UL listed, UL Certification on request.

### DIMENSIONS & WEIGHT\*

H 330 x W 95 x D 100 mm, 3 kg

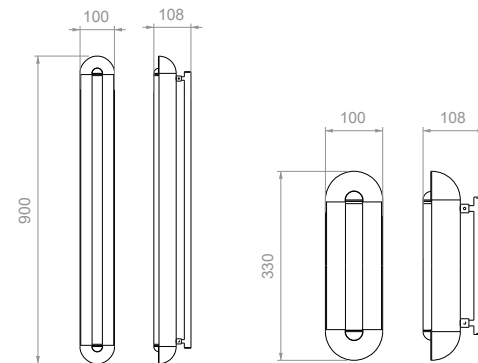

## COSMOS & COSMOS MINI

### MATERIALS

Brass

### FINISHES

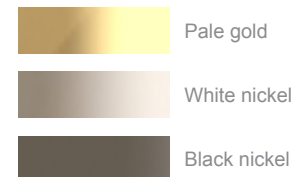

### LIGHT SOURCE

24V LED strip, 16 Watts/ mini 6 Watts,  
dimmable, class 3

Driver necessary

CE certification or US wired, all components are  
UL listed, UL Certification on request.



### DIMENSIONS & WEIGHT\*

H 900 x W 100 x D 108 mm, 8 kg

mini : H 330 x W 100 x D 108 mm, 5 kg

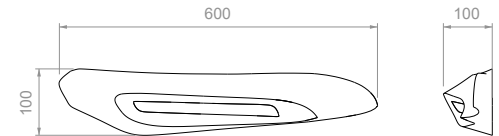
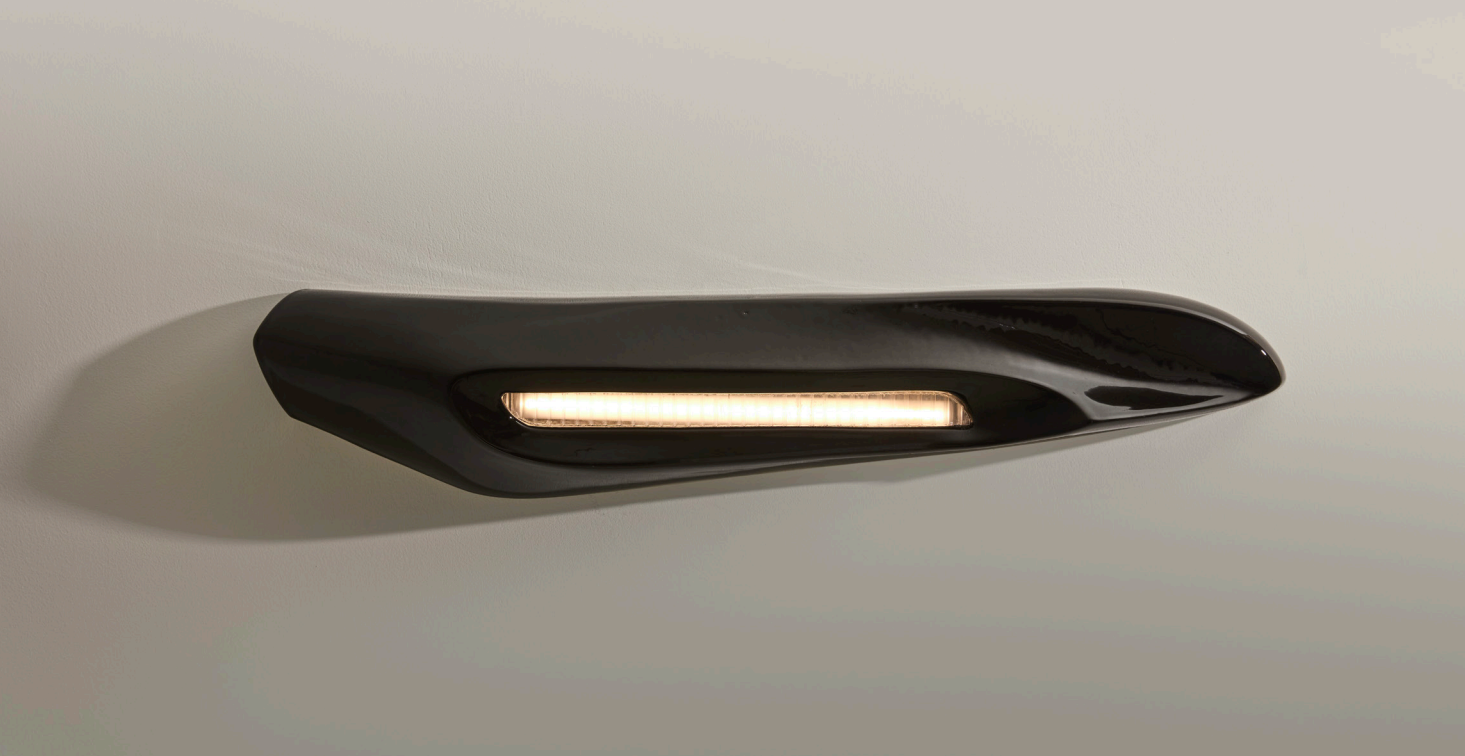

## MYDSC 1

### MATERIALS

Ceramic and brass

### FINISHES

 Glazed ceramic

 Directional brushing - Glossy transparent varnish

### LIGHT SOURCE

24 LED strip, 5 Watts, dimmable, class 3

Driver necessary

CE certification or US wired, all components are UL listed, UL Certification on request.



### DIMENSIONS & WEIGHT\*

H 100 x W 600 x P 100 mm, 3 kg





## NOVA - CONSOLE

---

### MATERIALS

Polished brass and straw marquetry

### FINISHES

-  Polished pale gold
-  Polished white nickel
-  Polished black nickel

### DIMENSIONS & WEIGHT\*

H 232 x W 775 x D 310 mm, 30 kg

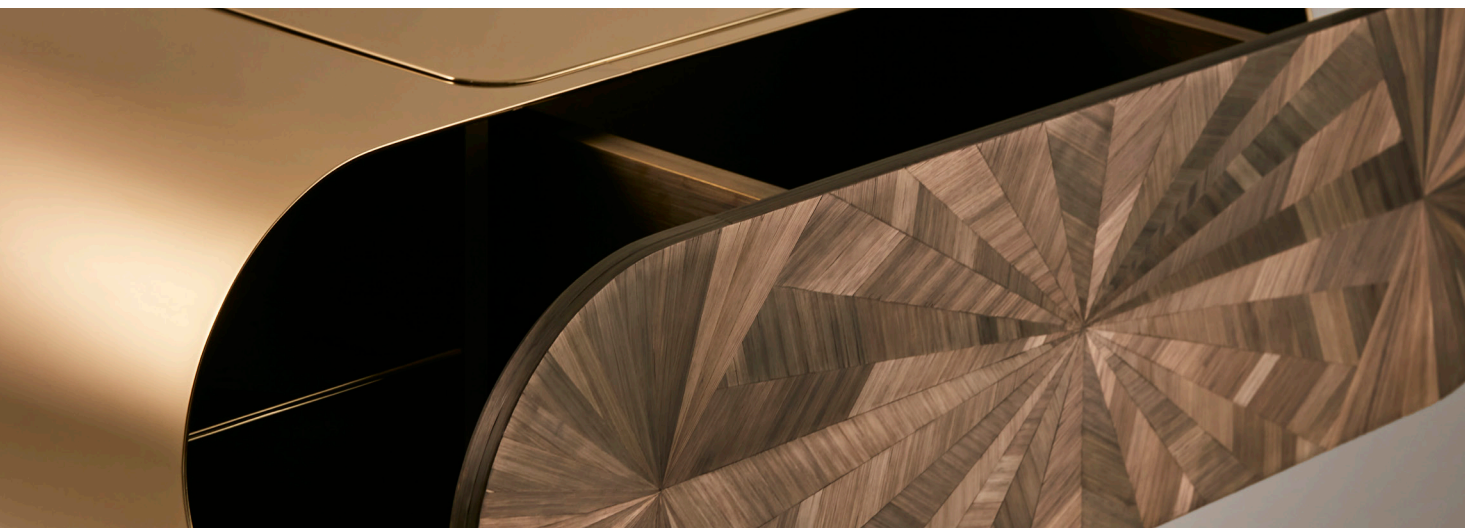

**CURVE**

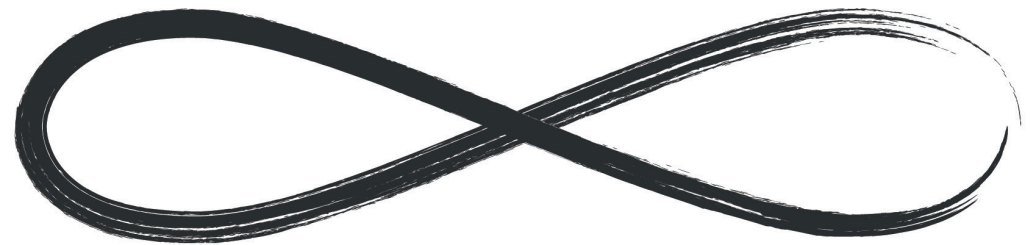



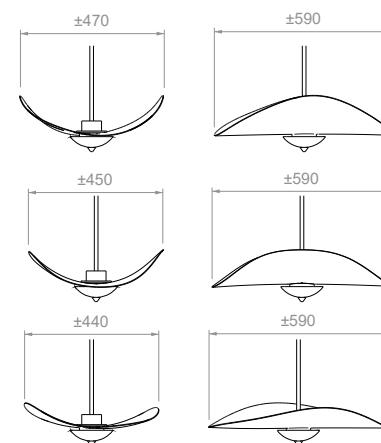



## ENVOLÉE

### MATERIALS

Brass

### FINISHES

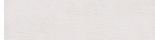
|   |                         |
|---|-------------------------|
|    | Polished pale gold      |
|   | Polished white nickel   |
|  | Polished lack nickel    |
|  | Porcelain bisque finish |

### LIGHT SOURCE

24V LED strip, 9 Watts, dimmable, class 3  
Driver necessary

CE certification or US wired, all components are  
UL listed, UL Certification on request.



### DIMENSIONS & WEIGHT\*

S : H variable x W 440 x L 590 mm, 7 kg

M : H variable x W 450 x L 590 mm, 7 kg

L : H variable x W 470 x L 590 mm, 7 kg

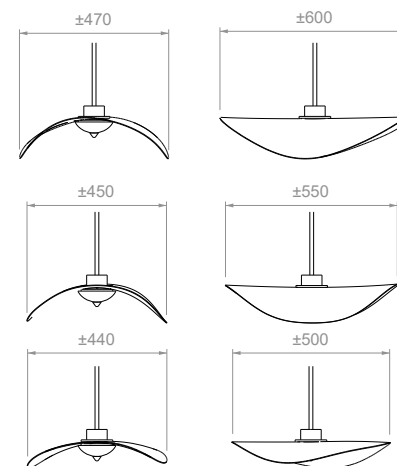



## ENVOLÉE VERRE

### MATERIALS

Glass and brass

### FINISHES

-  Blown glass (various colors)
-  Pale gold
-  White nickel
-  Black nickel

### LIGHT SOURCE

24V LED strip, 9 Watts, dimmable, class 3  
Driver necessary   
CE certification or US wired, all components are  
UL listed, UL Certification on request.

### DIMENSIONS & WEIGHT\*

S : H variable x W 440 x L 590 mm, 9 kg  
M : H variable x W 450 x L 590 mm, 9 kg  
L : H variable x W 470 x L 590 mm, 9 kg



Composition of three *Envolée verre* pendants.

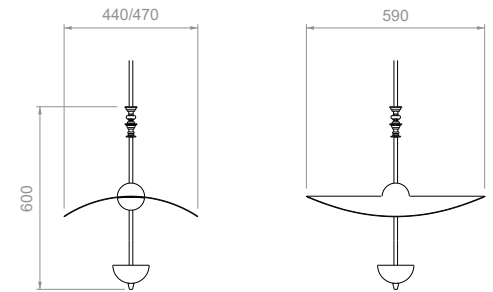





## ENVOLEE DOUBLE - 1 ELEMENT

### MATERIALS

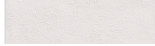
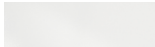
Brass

### FINISHES

|   |                         |
|---|-------------------------|
|    | Porcelain bisque finish |
|    | Porcelain finish        |
|    | Pale gold               |
|   | White nickel            |
|  | Black nickel            |

### LIGHT SOURCE

24V LED disc, 7.5 Watts, dimmable, class 3

Driver necessary

CE certification or US wired, all components are UL listed, UL Certification on request.



### DIMENSIONS & WEIGHT\*

S : H 600 x W 440 x L 590 mm, +/- 10 kg

M : H 600 x W 470 x L 590 mm, +/- 10 kg

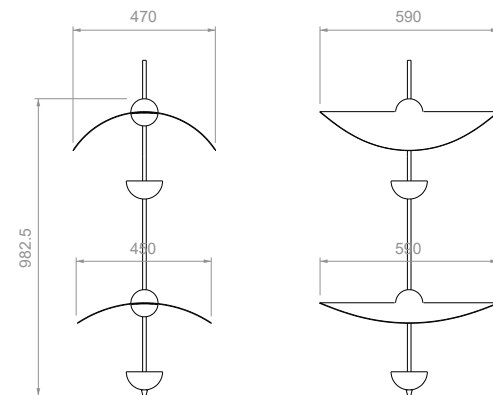





## ENVOLEE DOUBLE - 2 ELEMENTS

### MATERIALS

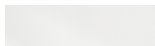
Brass

### FINISHES

|   |                         |
|---|-------------------------|
|    | Porcelain bisque finish |
|    | Porcelain finish        |
|    | Pale gold               |
|   | White nickel            |
|  | Black nickel            |

### LIGHT SOURCE

2 x 24V LED disc, 15 Watts, dimmable, class 3

Driver necessary

CE certification or US wired, all components are UL listed, UL Certification on request.



### DIMENSIONS & WEIGHT\*

H 982.5 x W 470 x L 590 mm, +/- 18 kg  
Custom



*Envolée*, suspension with porcelain bisque finish.  
*Envolée double*, suspension with two elements. *Cube 6*, wall light.

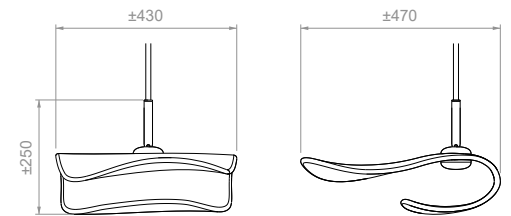



## BRUME

---

### MATERIALS

Blown glass and brass

### FINISHES

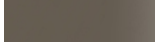
-  Blown glass (various colors)
-  Polished pale gold
-  Polished white nickel
-  Polished black nickel

### LIGHT SOURCE

24V LED disc, 5 Watts, dimmable, class 3  
Driver necessary

CE certification or US wired, all components are  
UL listed, UL Certification on request.



### DIMENSIONS & WEIGHT\*

H +/-250 x W +/-430 x L +/-470 mm, 12 kg

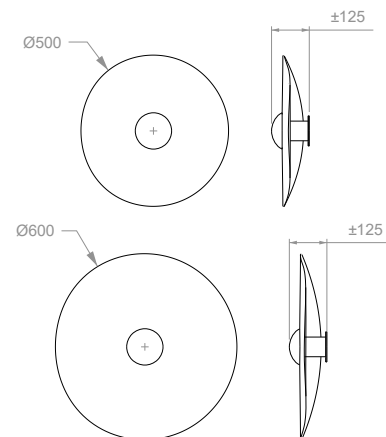
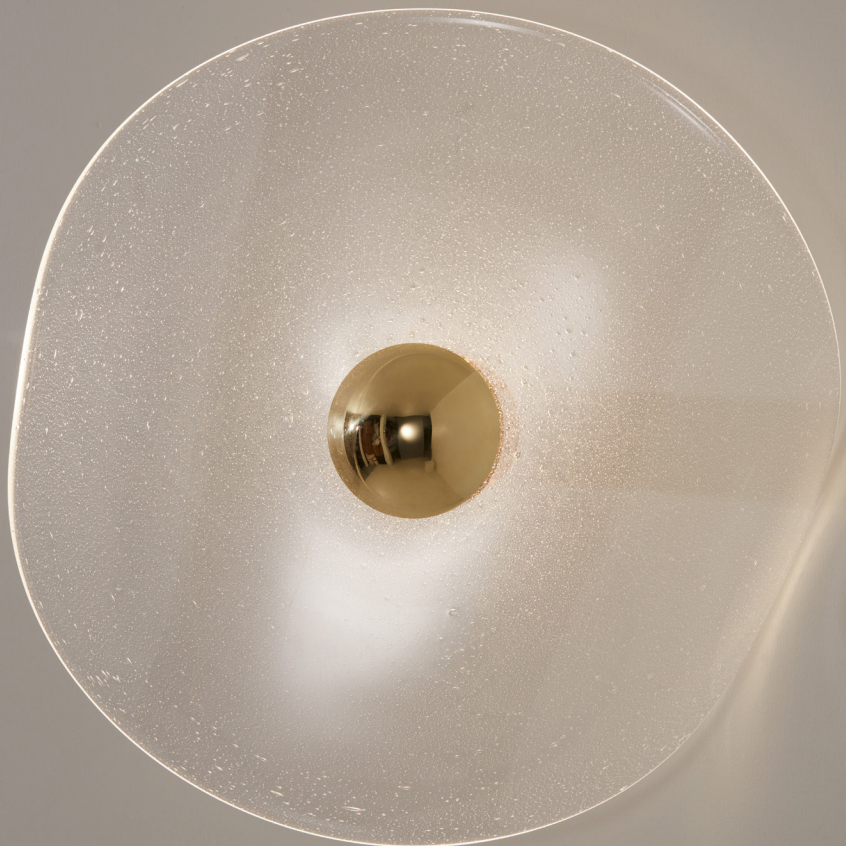



## CONSTELLATION

---

### MATERIALS

Bubble-blown glass and brass

### FINISHES

-  Polished pale gold
-  Polished white nickel
-  Polished black nickel

### LIGHT SOURCE

24V LED strip, 8 Watts, dimmable, class 3

Driver necessary

CE certification or US wired, all components are UL listed, UL Certification on request.



### DIMENSIONS & WEIGHT\*

S : Ø 500 x D 125 mm, 8 kg

M : Ø 600 x D 125 mm, 8 kg



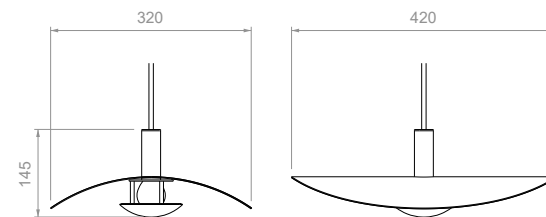

## LOÏE

---

**MATERIALS**  
Brass

**FINISHES**



Polished brass



Colored varnish (various colors)

**LIGHT SOURCE**

Light bulb E14/220V or E12/110V,  
4 to 7 Watts, dimmable, class 2

CE certification or US wired, all components are  
UL listed, UL Certification on request.



**DIMENSIONS & WEIGHT\***  
H 145 x W 420 x L 320 mm, 2 kg



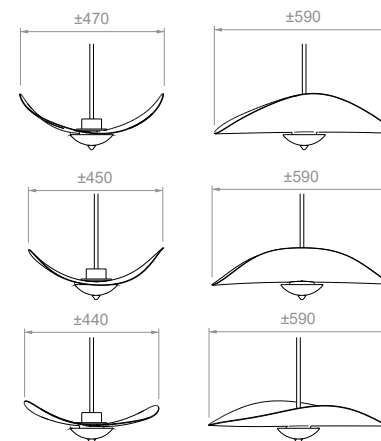

## ENVOLÉE CARAMEL

MATERIALS  
Brass

FINISHES

 Polished brass

 Colored varnish  
(various colors)

LIGHT SOURCE

24V LED strip, 9 Watts, dimmable, class 3

Driver necessary

CE certification or US wired, all components are  
UL listed, UL Certification on request.



DIMENSIONS & WEIGHT\*

S : H variable x W 440 x L 590 mm, 7 kg

M : H variable x W 450 x L 590 mm, 7 kg

L : H variable x W 470 x L 590 mm, 7 kg

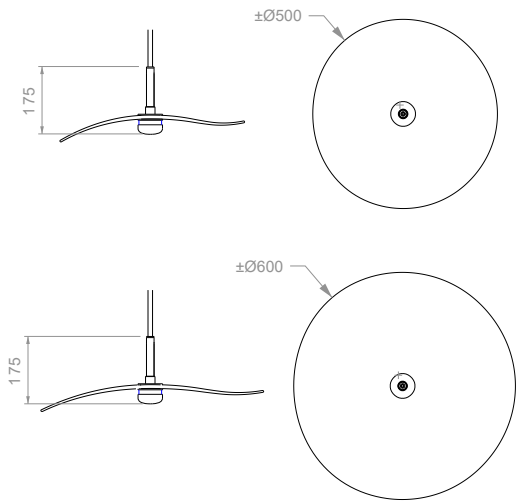



## ASTRALE

### MATERIALS

Bubble-blown glass and brass

### FINISHES

|   |                       |
|---|-----------------------|
|    | Polished pale gold    |
|   | Polished white nickel |
|  | Polished black nickel |

### LIGHT SOURCE

24V LED disc, 5 Watts, dimmable, class 3

Driver necessary

CE certification or US wired, all components are UL listed, UL Certification on request.



### DIMENSIONS & WEIGHT\*

S : H 175 x Ø 500 mm, 9 kg

M : H 175 x Ø 600 mm, 9 kg

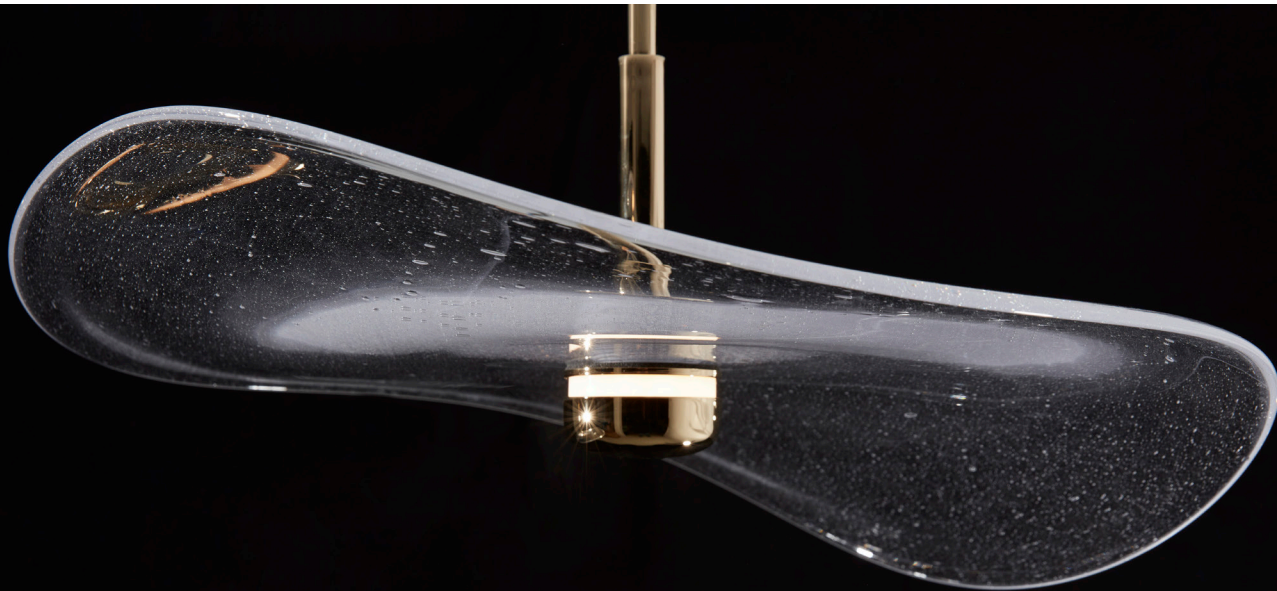

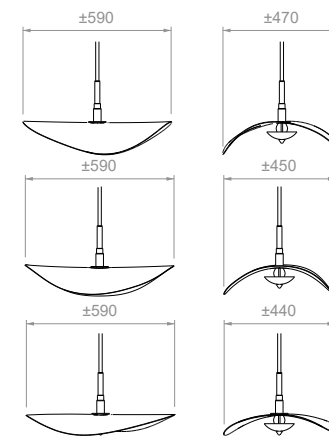



## ÉCHAPPÉE

MATERIALS  
Brass

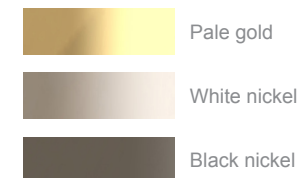
### FINISHES



### LIGHT SOURCE

Light bulb E14/220V or E12/110V,  
4 to 7 Watts, dimmable, class 1   
CE certification or US wired, all components are  
UL listed, UL Certification on request.

### DIMENSIONS & WEIGHT\*

S : H variable x W 440 x L 590 mm, 5 kg  
M : H variable x W 450 x L 590 mm, 5 kg  
L : H variable x W 470 x L 590 mm, 5 kg

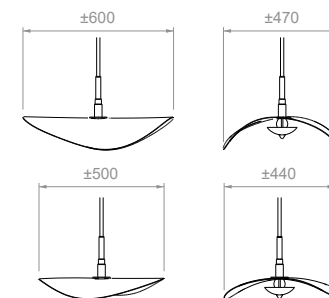

## ÉCHAPPÉE VERRE

### MATERIALS

Glass and brass

### FINISHES

|   |                              |
|---|------------------------------|
|    | Blown glass (various colors) |
|   | Pale gold                    |
|  | White nickel                 |
|  | Black nickel                 |

### LIGHT SOURCE

Light bulb E14/220V or E12/110V,  
4 to 7 Watts, dimmable, class 1

CE certification or US wired, all components are  
UL listed, UL Certification on request.



### DIMENSIONS & WEIGHT\*

S : H variable x W 440 x L 590 mm, 7 kg

M : H variable x W 450 x L 590 mm, 7 kg

L : H variable x W 470 x L 590 mm, 7 kg

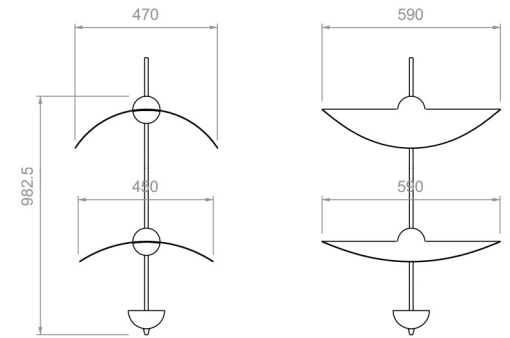





## ENVOLÉE DOUBLE AJOURÉE

### MATERIALS

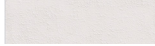
Brass

### FINISHES

|  |                         |
|--|-------------------------|
|   | Porcelain bisque finish |
|   | Pale gold               |
|   | White nickel            |
|  | Black nickel            |

### LIGHT SOURCE

24V LED disc, 7.5 Watts, dimmable, class 3

Driver necessary

CE certification or US wired, all components are UL listed, UL Certification on request.



### DIMENSIONS & WEIGHT\*

H 982.5 x W 470 x L 590 mm, +/- 18 kg  
Custom

**ELLIPSE**



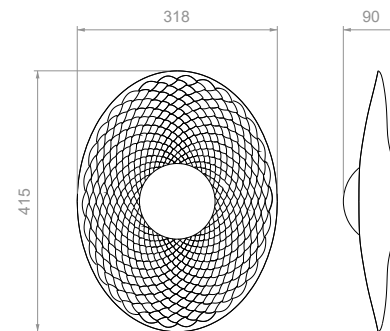



## CHISAII RYU

---

### MATERIALS

Plaster and brass

### FINISHES

-  Polished pale gold
-  Polished white nickel
-  Polished black nickel

### LIGHT SOURCE

24V LED strip, 5 Watts, dimmable, class 3 

Driver necessary

CE certification or US wired, all components are UL listed, UL Certification on request.

### DIMENSIONS & WEIGHT\*

H 415 x W 318 x D90 mm, 3 kg



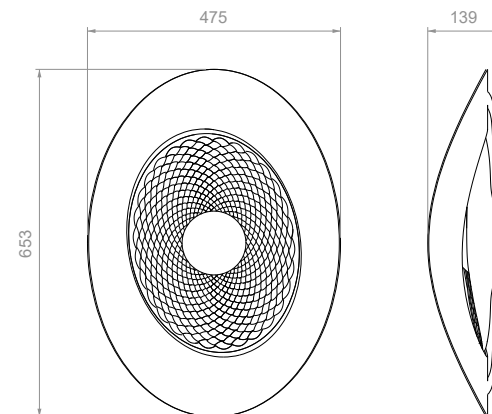



## RYU

### MATERIALS

Plaster and brass

### FINISHES

-  Polished pale gold
-  Polished white nickel
-  Polished black nickel

### LIGHT SOURCE

24V LED strip, 5 Watts, dimmable, class 3 

Driver necessary  
CE certification or US wired, all components are  
UL listed, UL Certification on request.

### DIMENSIONS & WEIGHT\*

H 653 x W 475 x D 139 mm, 12 kg



*Ryu*, wall light.



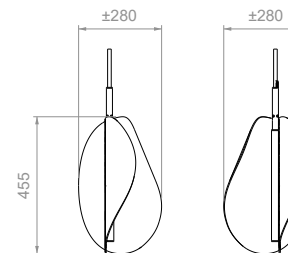
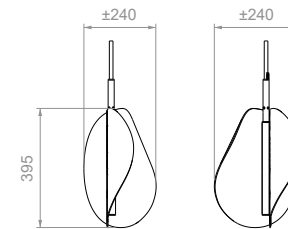



## COROLLE

### MATERIALS

Brass

### FINISHES

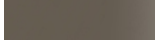
-  Porcelain bisque finish
-  Polished pale gold
-  Polished white nickel
-  Polished black nickel

### LIGHT SOURCE

24V LED strip, 9 Watts, dimmable, class 3

Driver necessary

CE certification or US wired, all components are UL listed, UL Certification on request.



### DIMENSIONS & WEIGHT\*

S : H 395 x W 240 x L 240 mm, 7 kg

L : H 455 x W 280 x L 280 mm, 8 kg

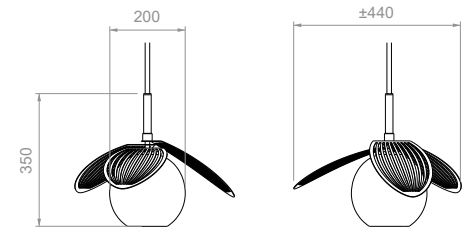





## JASMIN

### MATERIALS

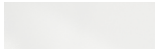
Blown glass and brass

### FINISHES

-  Blown glass (various colors)
-  Polished pale gold
-  Polished white nickel
-  Polished black nickel

### LIGHT SOURCE

24V LED disc, 7.5 Watts, dimmable, class 3

Driver necessary

CE certification or US wired, all components are UL listed, UL Certification on request.



### DIMENSIONS & WEIGHT\*

H +/-450 x W 200 x L 200 mm, 3.5 kg

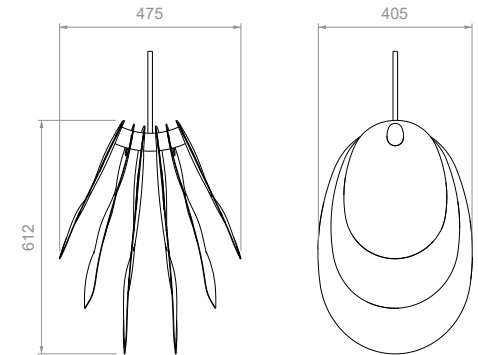
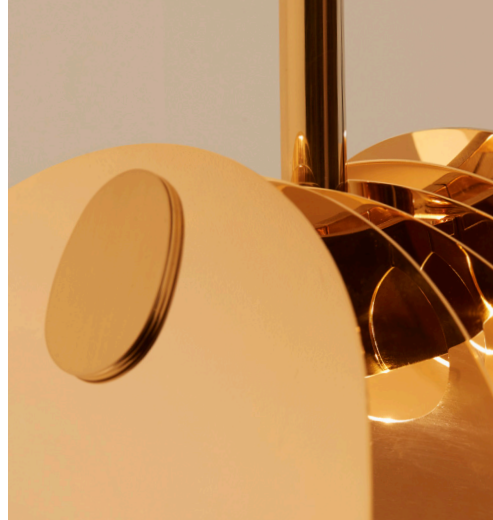



## ORCHIDÉE

---

**MATERIALS**  
Brass

**FINISHES**

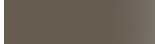
-  Polished pale gold
-  Polished white nickel
-  Polished black nickel

**LIGHT SOURCE**

24V LED strip, 5 Watts, dimmable, class 3  
Driver necessary

CE certification or US wired, all components are  
UL listed, UL Certification on request.



**DIMENSIONS & WEIGHT\***

H 612 x W 405 x L 475 mm, 13 kg

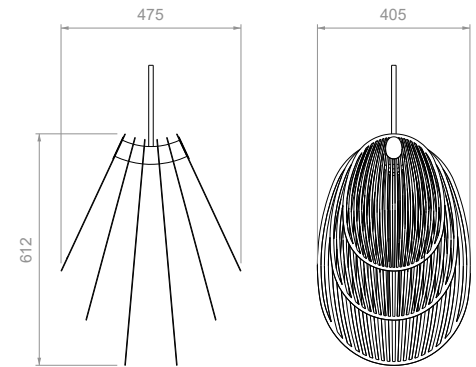

## ORCHIDÉE AJOURÉE

MATERIALS  
Brass

FINISHES

 Polished pale gold

 Polished white nickel

 Polished black nickel

LIGHT SOURCE  
24V LED strip, 5 Watts, dimmable, class 3   
Driver necessary  
CE certification or US wired, all components are  
UL listed, UL Certification on request.

DIMENSIONS & WEIGHT\*  
H 612 x W 405 x L 475 mm, 11 kg

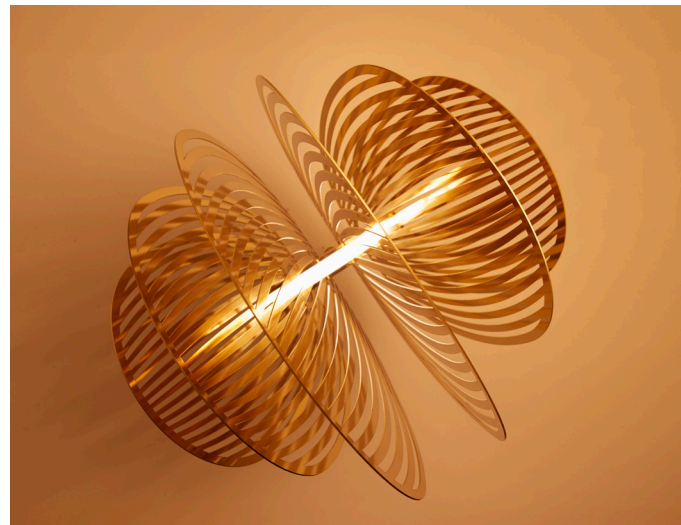

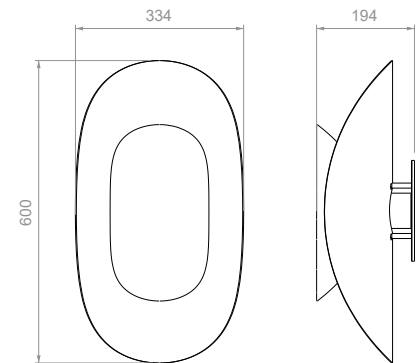





## PÉTALE

**MATERIALS**  
Brass

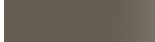
**FINISHES**

-  Polished pale gold
-  Polished white nickel
-  Polished black nickel

**LIGHT SOURCE**

Light bulb E14/220V or E12/110V,  
4 to 7 Watts, dimmable, class 1   
CE certification or US wired, all components are  
UL listed, UL Certification on request.

**DIMENSIONS & WEIGHT\***

H 600 x W 334 x L 194 mm, 10 kg

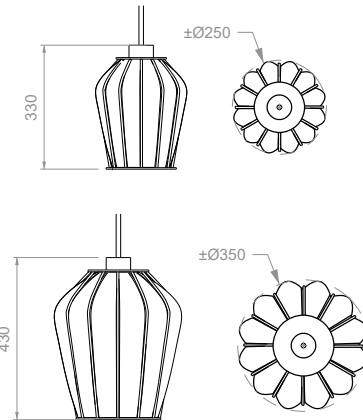



## SKY LANTERN

### MATERIALS

Blown glass and brass

### FINISHES

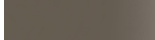
|   |                           |
|---|---------------------------|
|    | Opaline white blown glass |
|   | Polished pale gold        |
|  | Polished white nickel     |
|  | Polished black nickel     |

### LIGHT SOURCE

Gold light bulb E14/220V or E12/110V, 4 to 7  
Watts, dimmable, class 1

CE certification or US wired, all components are   
UL listed, UL Certification on request.

### DIMENSIONS & WEIGHT\*

S : H 330 x +/-Ø250 mm, 10 kg

M : H 430 x +/-Ø350 mm, 12 kg



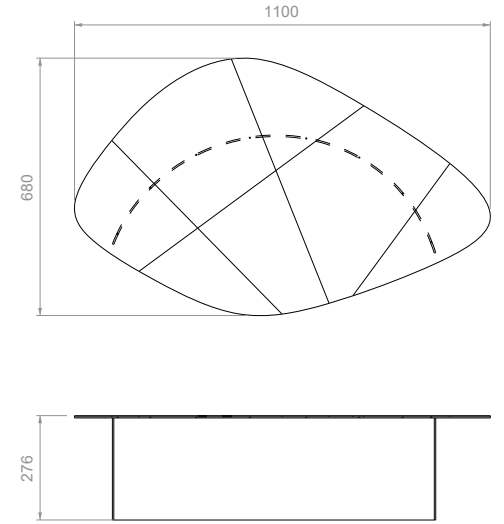

## LUNAIRE - COFFEE TABLE

MATERIALS  
Brass

FINISHES

 Polished pale gold

 Marbled finish

 Textured

DIMENSIONS & WEIGHT\*  
H 276 x W 680 x L 1100 mm, 35 kg



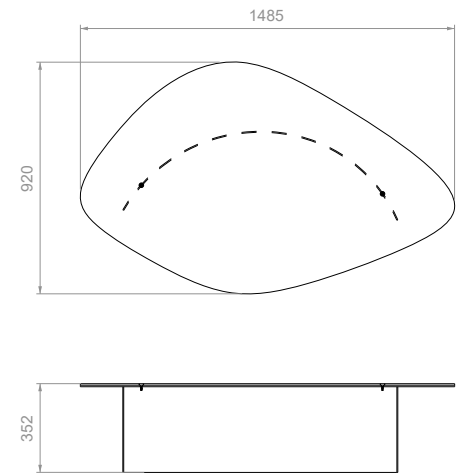

## ARC

---

### MATERIALS

Lacquered glass and brass

### FINISHES

 Lacquered glass  
(various colors)

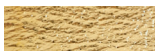
 Textured

### DIMENSIONS & WEIGHT\*

H 352 x W 920 x L 1485 mm, 25 kg

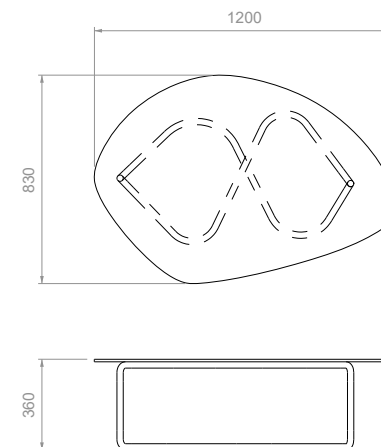

## AQUARELLE

### MATERIALS

Lacquered glass and brass

### FINISHES



Lacquered glass  
(various colors)

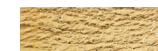

Textured

### DIMENSIONS & WEIGHT\*

H 360 x W 830 x L 1200 mm, 25 kg



**GEOMETRIC**

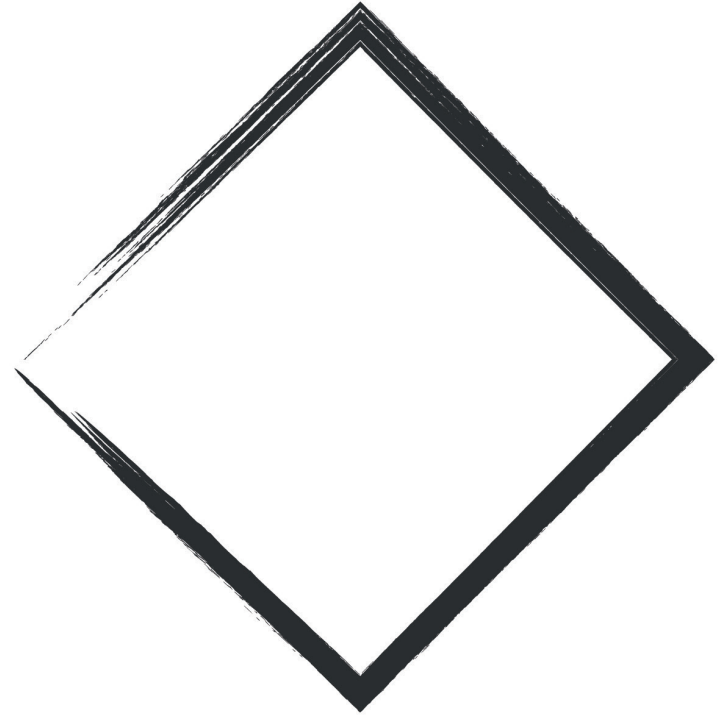

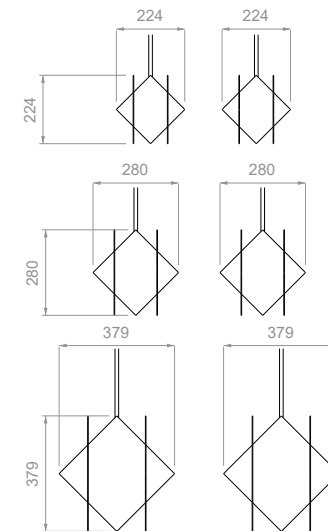
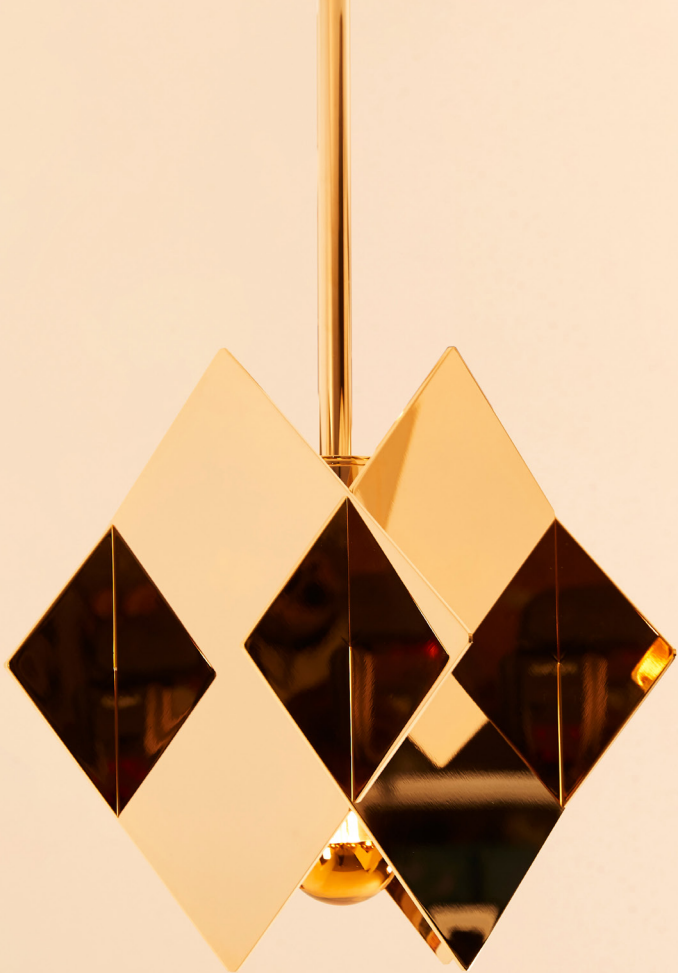



## PRISME

### MATERIALS

Brass

### FINISHES

-  Polished pale gold
-  Polished white nickel
-  Polished black nickel

### LIGHT SOURCE

Gold light bulb E14/220V or E12/110V, 4 to 7 Watts, dimmable, class 1

CE certification or US wired, all components are UL listed, UL Certification on request.

### DIMENSIONS & WEIGHT\*

S : H 224 x W 224 x L 224 mm, 4 kg

M : H 280 x W 280 x L 280 mm, 6 kg

L : H 379 x W 379 x L 379 mm, 9 kg



Composition of *Prisme* suspensions. Cartier.

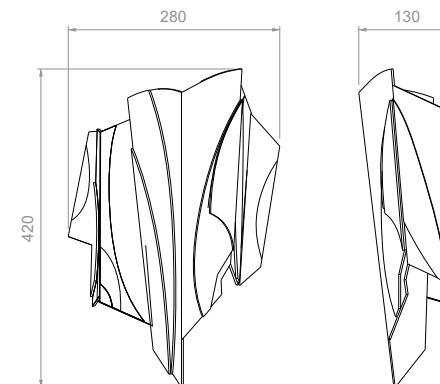



## CROSS BITUME 01

---

### MATERIALS

Brass

### FINISHES

-  Polished pale gold
-  Polished white nickel
-  Polished black nickel

### LIGHT SOURCE

24V LED strip, 5 Watts, dimmable, class 3   
Driver necessary  
CE certification or US wired, all components are  
UL listed, UL Certification on request.

### DIMENSIONS & WEIGHT\*

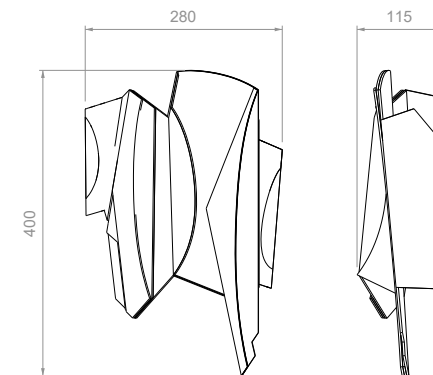
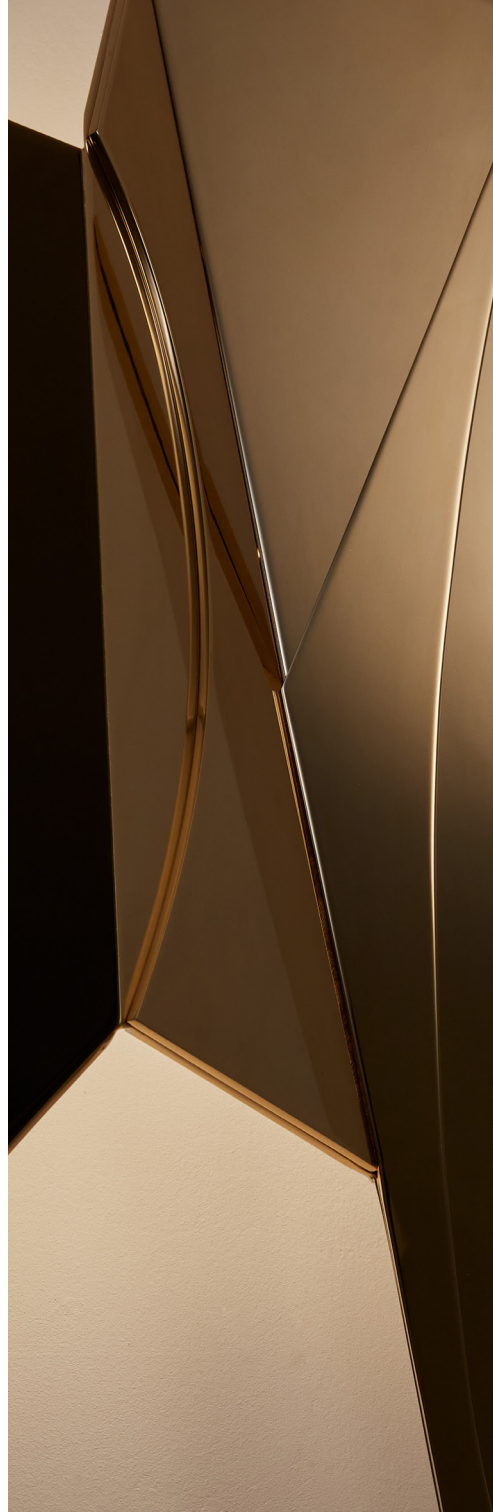

H 420 x W 280 x D 130 mm, 5 kg



## CROSS BITUME 02

MATERIALS  
Brass

### FINISHES

-  Polished pale gold
-  Polished white nickel
-  Polished black nickel

### LIGHT SOURCE

24V LED strip, 5 Watts, dimmable, class 3   
Driver necessary  
CE certification or US wired, all components are  
UL listed, UL Certification on request.

DIMENSIONS & WEIGHT\*  
H 400 x W 280 x D 115 mm, 5 kg



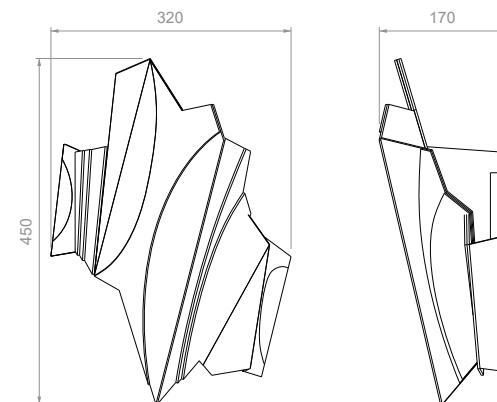
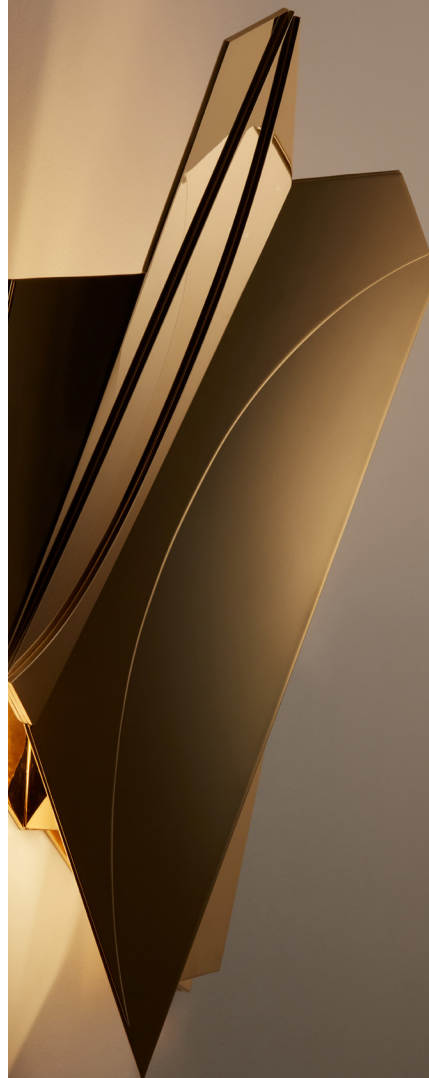



## CROSS BITUME 03

---

**MATERIALS**  
Brass

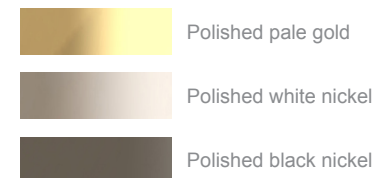
**FINISHES**



**LIGHT SOURCE**  
24V LED strip, 5 Watts, dimmable, class 3   
Driver necessary  
CE certification or US wired, all components are  
UL listed, UL Certification on request.

**DIMENSIONS & WEIGHT\***  
H 450 x W 320 x D 170 mm, 5 kg

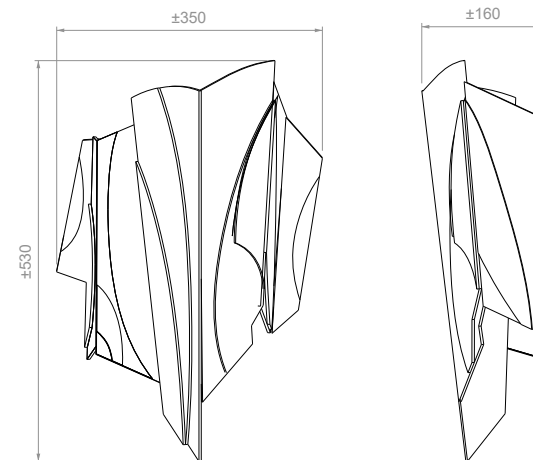





## CROSS BITUME XXL

### MATERIALS

Brass

### FINISHES

-  Polished pale gold
-  Polished white nickel
-  Polished black nickel
-  Dichroic glass

### LIGHT SOURCE

24V LED strip, 5 Watts, dimmable, class 3  
Driver necessary   
CE certification or US wired, all components are  
UL listed, UL Certification on request.

### DIMENSIONS & WEIGHT\*

H 530 x W 350 x D 160 mm, 6 kg



*Cross Bitume 03* wall light. *Flare* table lamps.

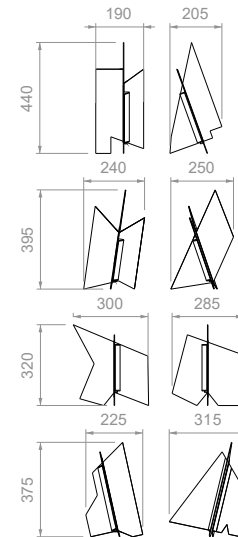

## FLARE

MATERIALS  
Brass

### FINISHES

 Polished white nickel

 Colored varnish  
(various colors)

### LIGHT SOURCE

24V LED strip, 5 Watts, dimmable, class 3  
Integrated driver

CE certification or US wired, all components are  
UL listed, UL Certification on request.

### DIMENSIONS & WEIGHT\*

FLARE 01 : H 440 x W 190 x L 205 mm, 2 kg

FLARE 02 : H 395 x W 240 x L 250 mm, 2 kg

FLARE 03 : H 320 x W 300 x L 285 mm, 2 kg

FLARE 04 : H 375 x W 225 x L 315 mm, 2 kg



FLARE 02



FLARE 01

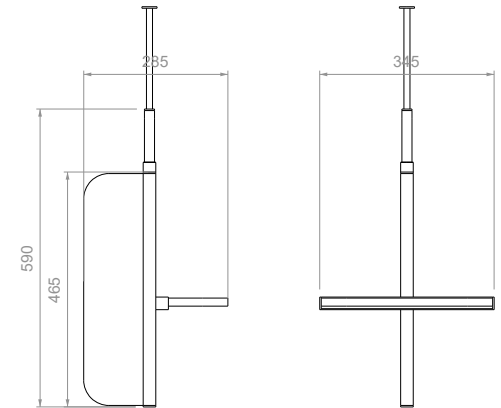

## AGATE

---

### MATERIALS

Fused glass and brass

### FINISHES



Brushed - Glossy/matt  
transparent varnish

### LIGHT SOURCE

24V LED strip, 17 Watts, dimmable, class 3   
Driver necessary  
CE certification or US wired, all components are  
UL listed, UL Certification on request.

### DIMENSIONS & WEIGHT\*

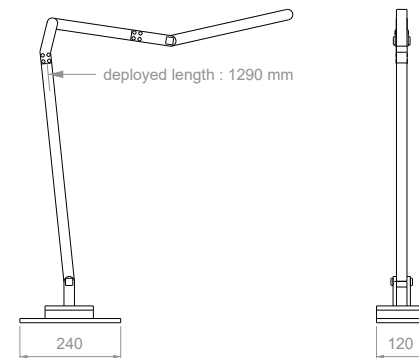

H 465 x W 285 x L 345 mm, 6 kg



## HÉRON

MATERIALS  
Brass

### FINISHES

-  Polished pale gold
-  Polished white nickel
-  Polished black nickel

### LIGHT SOURCE

220V LED strip, 50 Watts, dimmable, class 2   
CE certification or US wired, all components are  
UL listed, UL Certification on request.

### DIMENSIONS & WEIGHT\*

H 1290 x W 120 x D 240 mm, 5 kg

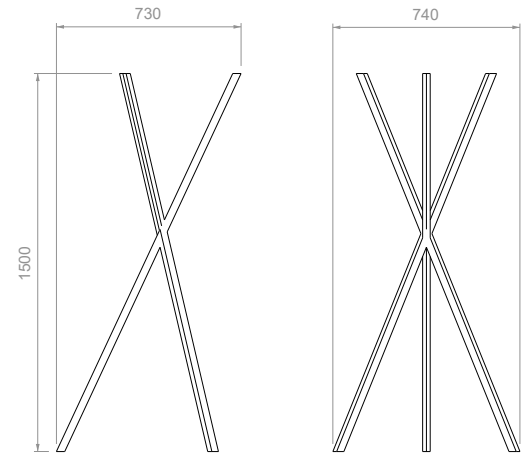

## PHASME - FLOOR LAMP

### MATERIALS

Brass

### FINISHES



Colored varnish  
(various colors)



Brushed black nickel



Brushed white nickel



Directional brushing - Glossy  
transparent varnish

### LIGHT SOURCE

220V LED strip, 100 Watts, dimmable,  
class 2

CE certification or US wired, all components are   
UL listed, UL Certification on request.

### DIMENSIONS & WEIGHT\*

H 1500 x W 740 x D 730 mm, 15 kg

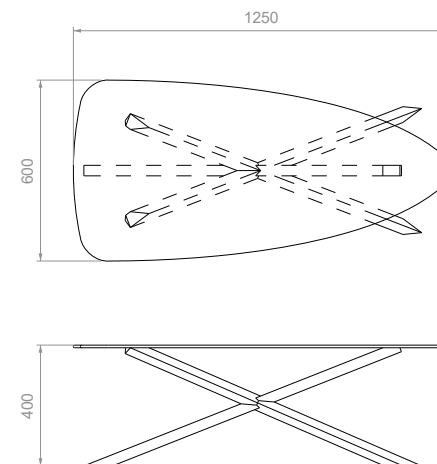
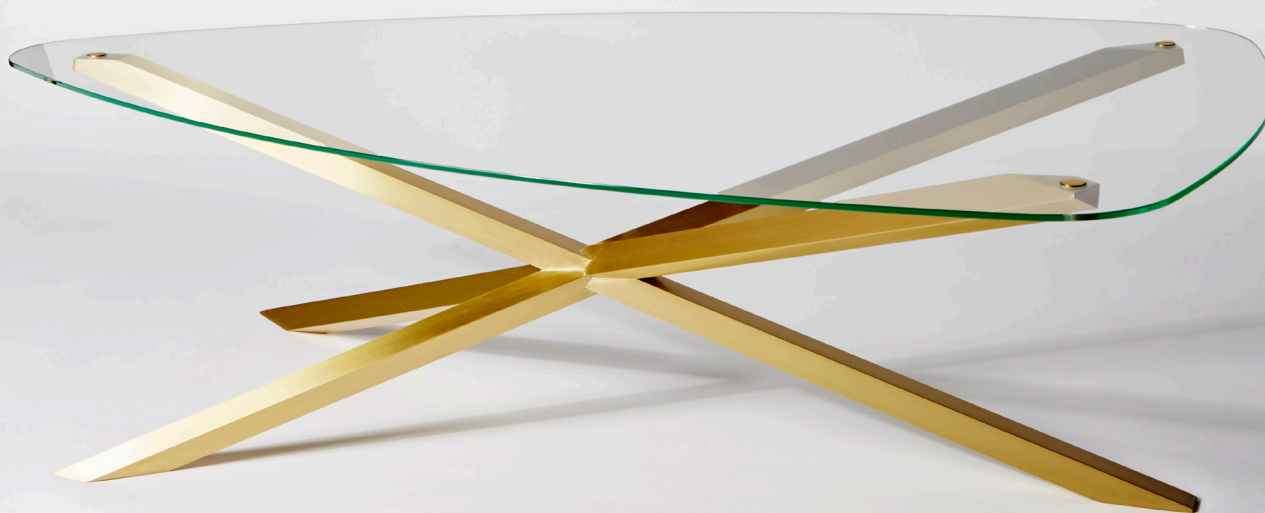

## PHASME - COFFEE TABLE

### MATERIALS

Glass and brass

### FINISHES

 Directional brushing - Glossy transparent varnish

 Brushed white nickel

 Brushed black nickel

### DIMENSIONS & WEIGHT\*

H 400 x W 600 x L 1250 mm, 30 kg



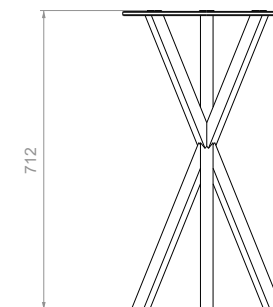
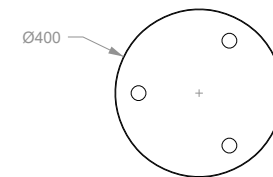

## PHASME - SIDE TABLE

### MATERIALS

Marble and brass

### FINISHES

 Directional brushing - Glossy transparent varnish

 Brushed white nickel

 Brushed black nickel

### DIMENSIONS & WEIGHT\*

H 712 x Ø400 mm, 15 kg





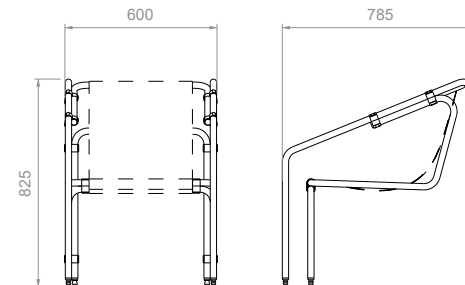

*Branches* pendant, *Dorique* armchair, *Phasme* coffee table, *Phasme* side table.



## DORIQUE

MATERIALS  
Brass and fabric

### FINISHES

|   |   |
|---|---|
|    | Directional brushing - Glossy transparent varnish |
|   | Brushed white nickel                              |
|  | Polished pale gold                                |
|  | Polished white nickel                             |

DIMENSIONS & WEIGHT\*  
H 825 x W 600 w L 785 mm, 17 kg

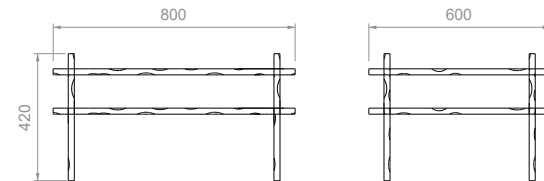

## FLUIDE - COFFEE TABLE

### MATERIALS

Glass, marble and brass

### FINISHES

 Polished pale gold

 Polished white nickel

 Polished black nickel

### DIMENSIONS & WEIGHT\*

H 420 x W 600 x L 800 mm  
17 kg



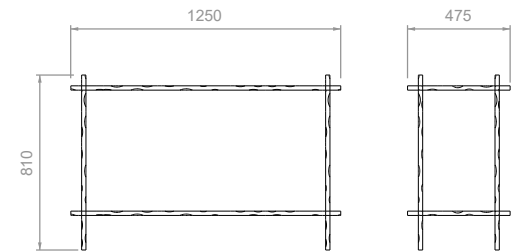

## FLUIDE - SIDE TABLE

MATERIALS  
Glass and brass

### FINISHES

 Polished pale gold

 Polished white nickel

 Polished black nickel

DIMENSIONS & WEIGHT\*  
H 810 x W475 x L 1250 mm, 15 kg  
Custom



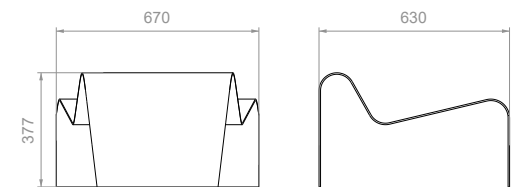

## LUNAIRE - ARMCHAIR

---

MATERIALS  
Brass

FINISHES



Marbled finish

DIMENSIONS & WEIGHT\*  
H 337 x W 670 x L 630 mm, 25 kg

**ROUND**

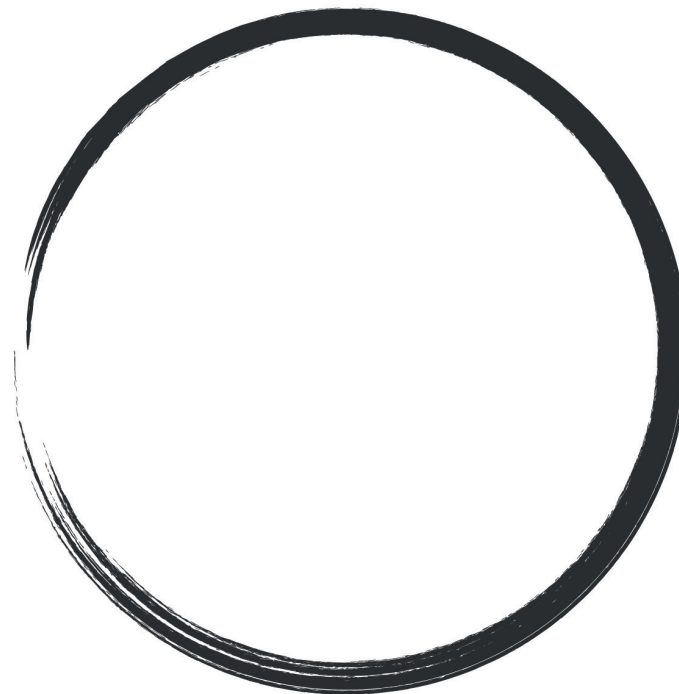

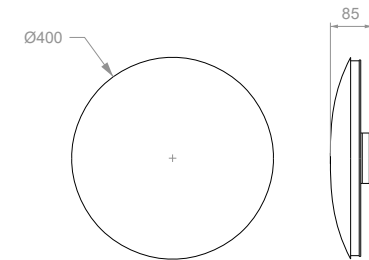
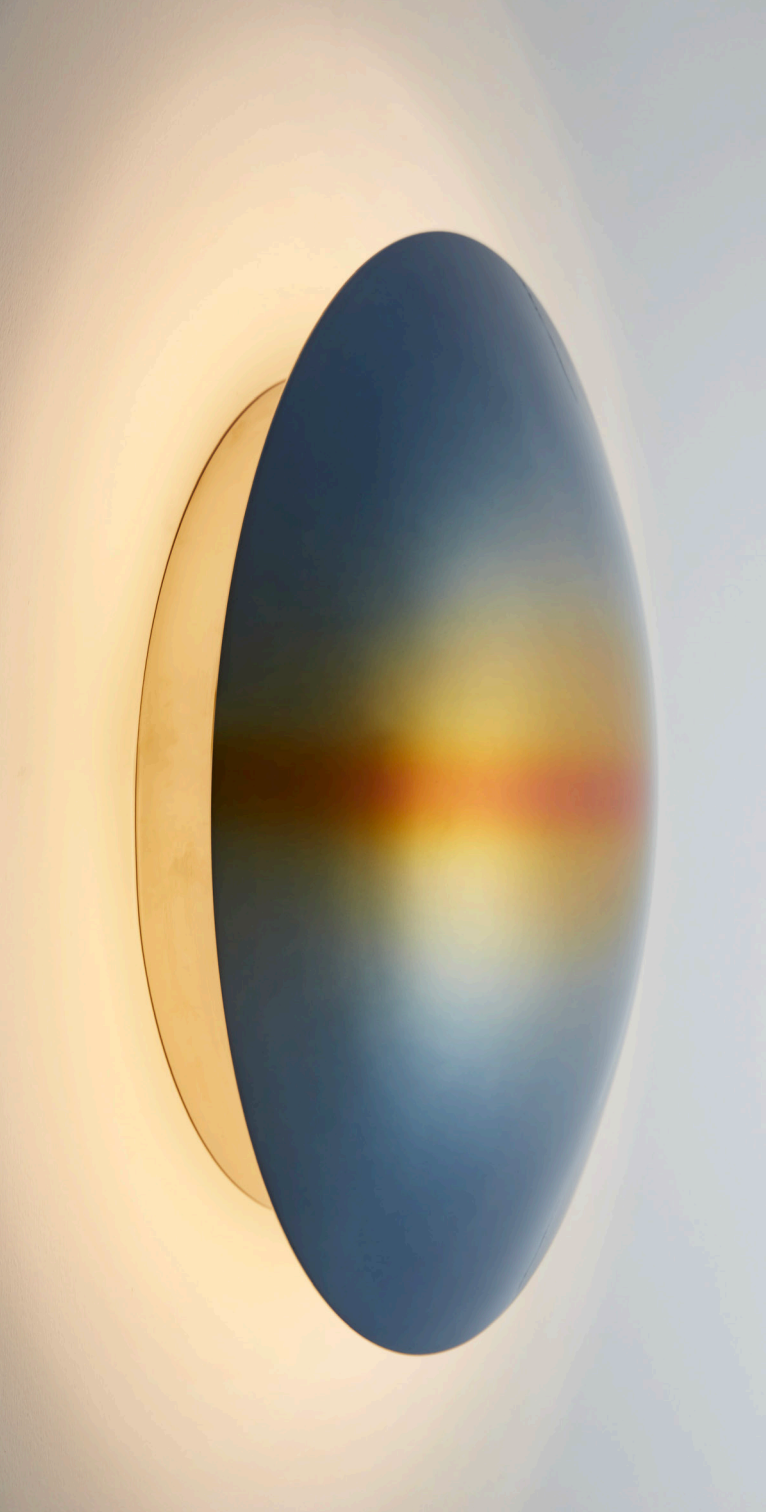

## CRÉPUSCULE

MATERIALS  
Brass

### FINISHES



LIGHT SOURCE  
24V LED strip, 30 Watts, dimmable, class 3   
Driver necessary  
CE certification or US wired, all components are  
UL listed, UL Certification on request.

DIMENSIONS & WEIGHT\*  
S : Ø400 x D 85 mm, 2.5 kg





*Brume* pendants, *Crépuscule 01 et 02* wall lights,  
*Merveilleux 02* stool, *Arc* coffee table, *Soleil Levant* rug.

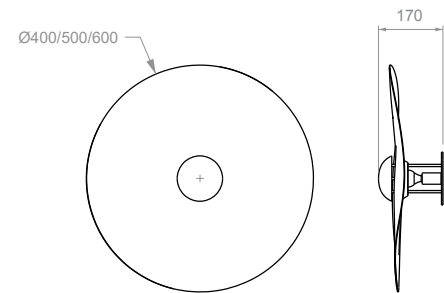

## MERCURE - WALL LAMP

### MATERIALS

Brass

### FINISHES

 Polished pale gold

 Polished white nickel

 Polished black nickel

### LIGHT SOURCE

Light bulb E14/220V or E12/110V,  
4 to 7 Watts, dimmable, class 1

CE certification or US wired, all components are  
UL listed, UL Certification on request.



### DIMENSIONS & WEIGHT\*

S : Ø400 mm x D 170 mm, 3.5 kg

M : Ø500 mm x D 170 mm, 4 kg

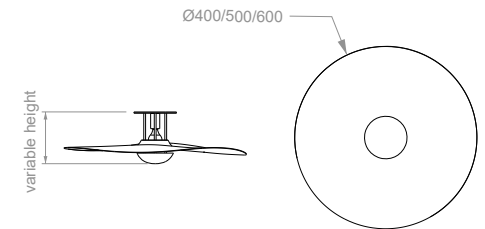

L : Ø600 mm x D 170 mm, 5 kg



## MERCURE - PENDANT

**MATERIALS**  
Brass

**FINISHES**

-  Polished pale gold
-  Polished white nickel
-  Polished black nickel

**LIGHT SOURCE**

Light bulb E14/220V or E12/110V,  
4 to 7 Watts, dimmable, class 1   
CE certification or US wired, all components are  
UL listed, UL Certification on request.

**DIMENSIONS & WEIGHT\***

S : variable height x Ø400 mm, 3.5 kg  
M : variable height x Ø500 mm, 4 kg  
L : variable height x Ø600 mm, 5 kg

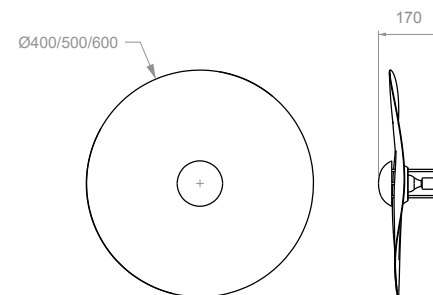

## SATURNE

---

**MATERIALS**  
Brass

**FINISHES**  
 Directional brushing - Glossy transparent varnish

**LIGHT SOURCE**  
Light bulb E14/220V or E12/110V,  
4 to 7 Watts, dimmable, class 1   
CE certification or US wired, all components are  
UL listed, UL Certification on request.

**DIMENSIONS & WEIGHT\***  
S : Ø400 mm x D 170 mm, 3.5 kg  
M : Ø500 mm x D 170 mm, 4 kg  
L : Ø600 mm x D 170 mm, 5 kg

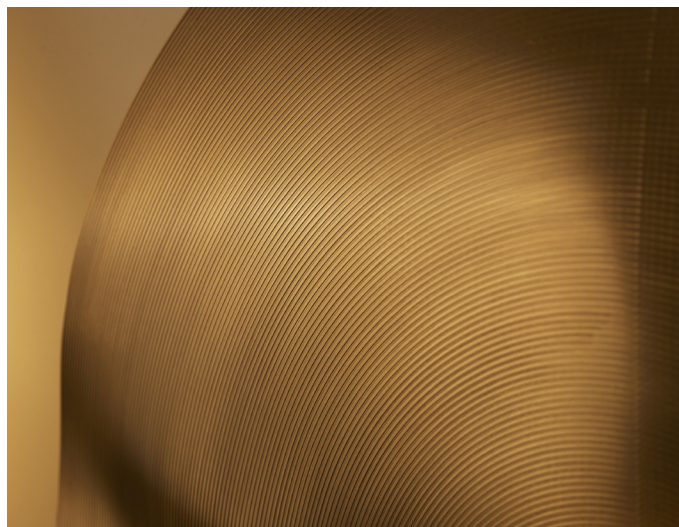

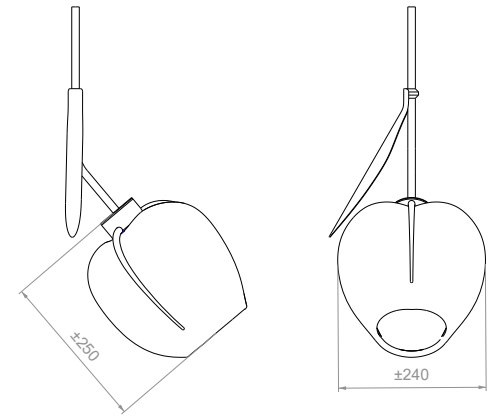



## MUGUET

### MATERIALS

Blown glass and brass

### FINISHES

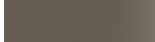
|   |                           |
|---|---------------------------|
|    | Opaline white blown glass |
|   | Polished pale gold        |
|  | Polished white nickel     |
|  | Polished black nickel     |

### LIGHT SOURCE

Light bulb E14/220V or E12/110V,  
4 to 7 Watts, dimmable, class 1

CE certification or US wired, all components are  
UL listed, UL Certification on request.



**DIMENSIONS & WEIGHT\***  
H ± 250 x Ø±/240 mm, 5 kg

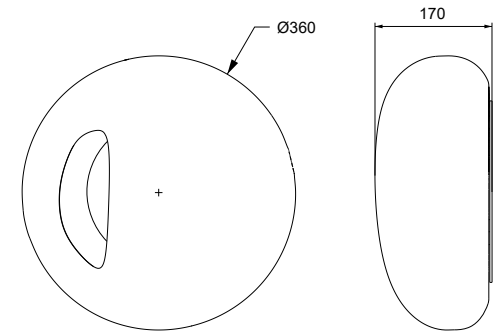

## MERVEILLEUX - WALL LAMP

### MATERIALS

Ceramic and brass

### FINISHES

 Tinted ceramic - white or black

 Lacquered brass

### LIGHT SOURCE

Light bulb E14/220V or E12/110V,

4 to 7 Watts, dimmable, class 1

CE certification or US wired, all components are  
UL listed, UL Certification on request.



### DIMENSIONS & WEIGHT\*

Ø360 x D 170 mm, 3 kg

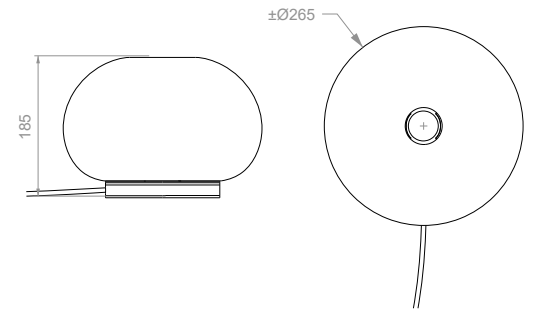

## SGRAFFITO 01

### MATERIALS

Porcelain and brass

### FINISHES

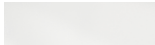
 Porcelain

 Brushed brass chrome

### LIGHT SOURCE

Light bulb E14/220V or E12/110V,

4 to 7 Watts, dimmable, class 2

CE certification or US wired, all components are UL listed, UL Certification on request.



**DIMENSIONS & WEIGHT\***  
H 185 x +/-Ø265 mm, 1.5 kg

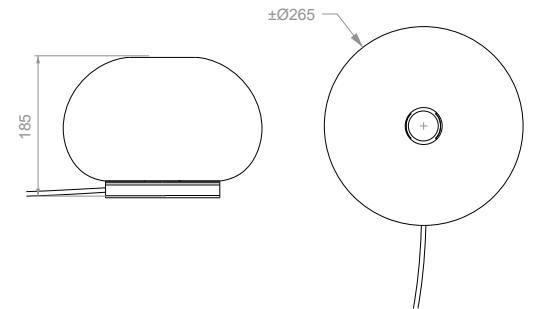

## SGRAFFITO 02

**MATERIALS**  
Porcelain

**FINISHES**

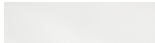
 Porcelain

 Brushed brass chrome

**LIGHT SOURCE**

Light bulb E14/220V or E12/110V,  
4 to 7 Watts, dimmable, class 2

CE certification or US wired, all components are   
UL listed, UL Certification on request.

**DIMENSIONS & WEIGHT\***  
H 185 x +/-Ø265 mm, 1.5 kg





*Phasme* floor lamp, *Aquarelle* coffee table, *Petit Drapé* candleholder, *Cannelé* vase, *Merveilleux* wall lights. *Sgraffito 02* table lamp.

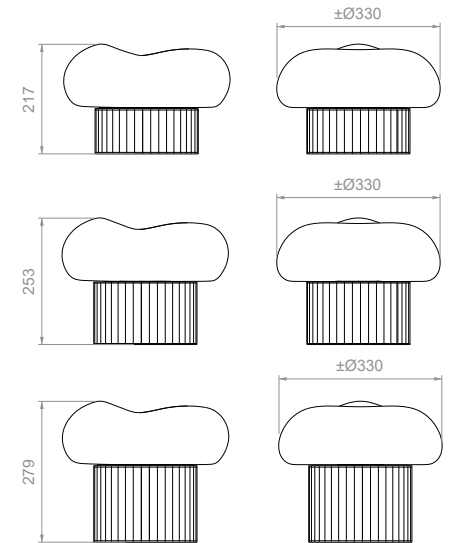

## MERVEILLEUX 01

**MATERIALS**  
Ceramic and brass

**FINISHES**

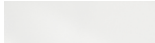
|  |                |
|--|----------------|
|   | Textured       |
|  | Glazed ceramic |

**DIMENSIONS & WEIGHT\***  
S : H 217 x +/-Ø330 mm, 9 kg  
M : H 253 x +/-Ø330 mm, 10 kg  
L : H 279 x +/-Ø330 mm, 12 kg

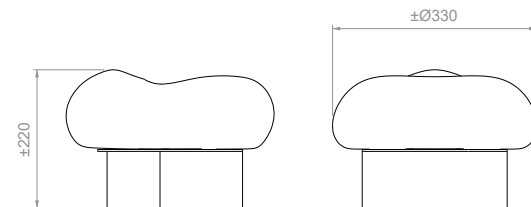

## MERVEILLEUX 02

---

MATERIALS  
Ceramic and brass

FINISHES

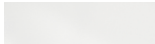
|  |                     |
|--|---------------------|
|   | Raw varnished brass |
|  | Glazed ceramic      |

DIMENSIONS & WEIGHT\*  
H 220 x +/-Ø330 mm, 4.5 kg

**MULTIPLE**

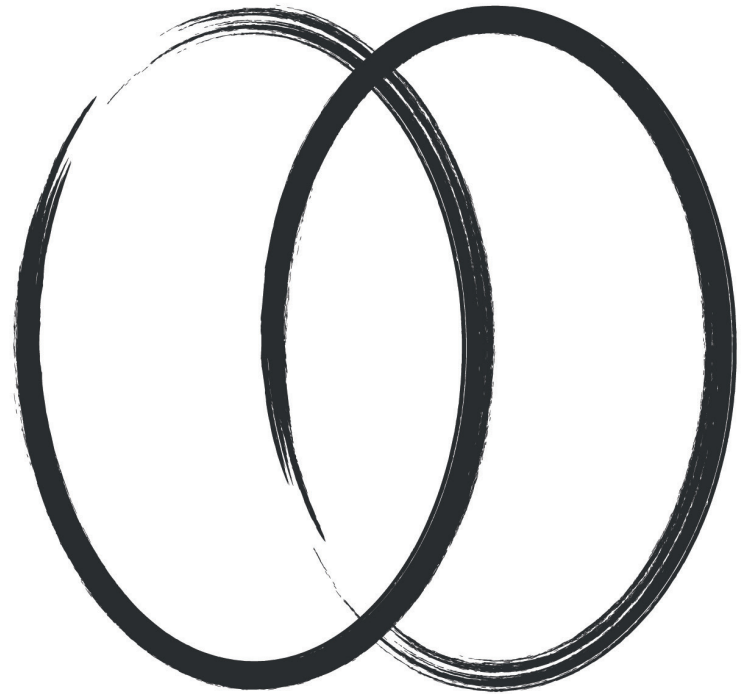

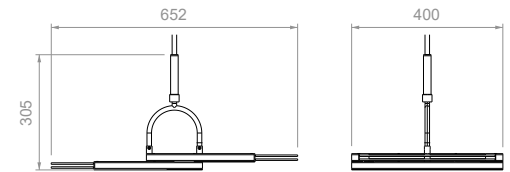

## ENTRELACS - PENDANT

### MATERIALS

Textured glass and brass

### FINISHES

 Polished pale gold

 Polished white nickel

 Polished black nickel

### LIGHT SOURCE

24V LED strip, 36 Watts, dimmable, class 3   
Driver necessary  
CE certification or US wired, all components are  
UL listed, UL Certification on request.

### DIMENSIONS & WEIGHT\*

H 305 x W 652 x L 400 mm, 6 kg

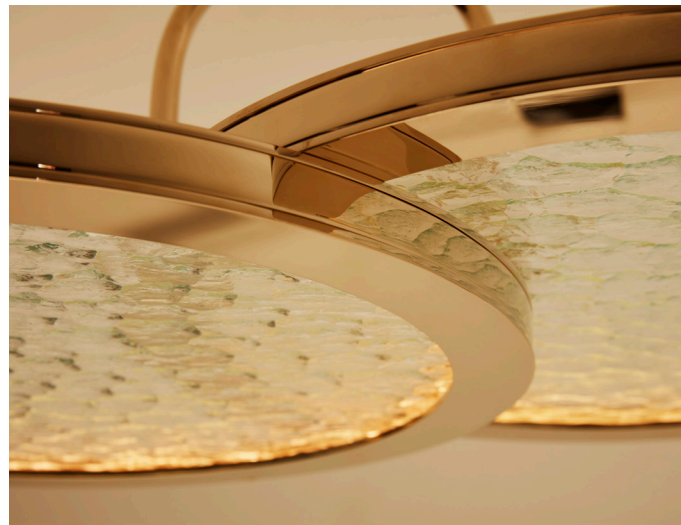
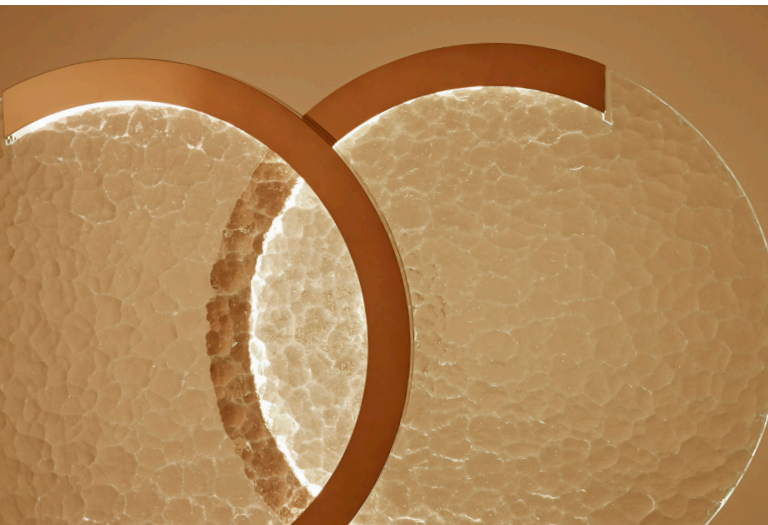

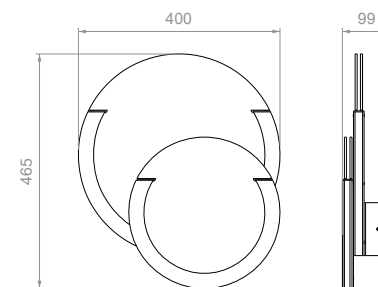



## ENTRELACS - WALL LAMP

### MATERIALS

Textured glass and brass

### FINISHES

-  Polished pale gold
-  Polished white nickel
-  Polished black nickel

### LIGHT SOURCE

24V LED strip, 30 Watts, dimmable, class 3   
Driver necessary  
CE certification or US wired, all components are  
UL listed, UL Certification on request.

### DIMENSIONS & WEIGHT\*

H 465 x W 400 x D 99 mm, 6 kg

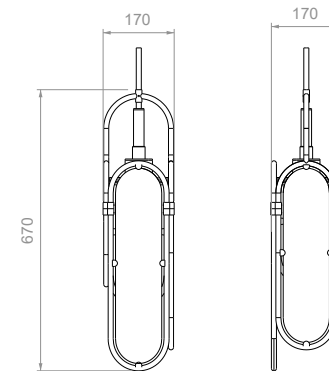



## BOUDOIR

---

### MATERIALS

Textured glass and brass

### FINISHES

-  Polished pale gold
-  Polished white nickel
-  Polished black nickel

### LIGHT SOURCE

Light bulb E14/220V or E12/110V,  
4 to 7 Watts, dimmable, class 1

CE certification or US wired, all components are  
UL listed, UL Certification on request.



### DIMENSIONS & WEIGHT\*

H 670 x W 170 x L 170 mm, 7 kg

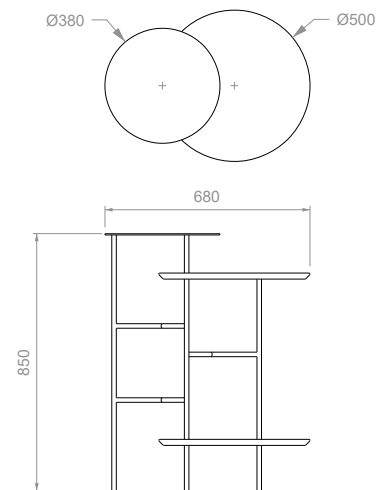

## ECLIPSE - SIDE TABLE

### MATERIALS

Marble, colored glass and brass

### FINISHES



Directional brushing - Glossy transparent varnish



Marble (various colors)

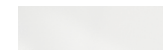

Colored glass (various colors)

### DIMENSIONS & WEIGHT\*

Small tray Ø380 mm

Big tray Ø500 mm

H 850 x W 500 x L 680 mm, +/- 25 kg



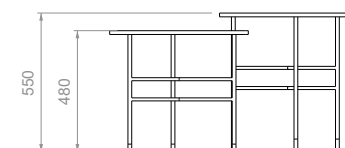
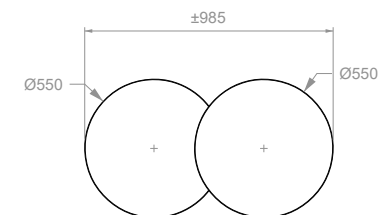
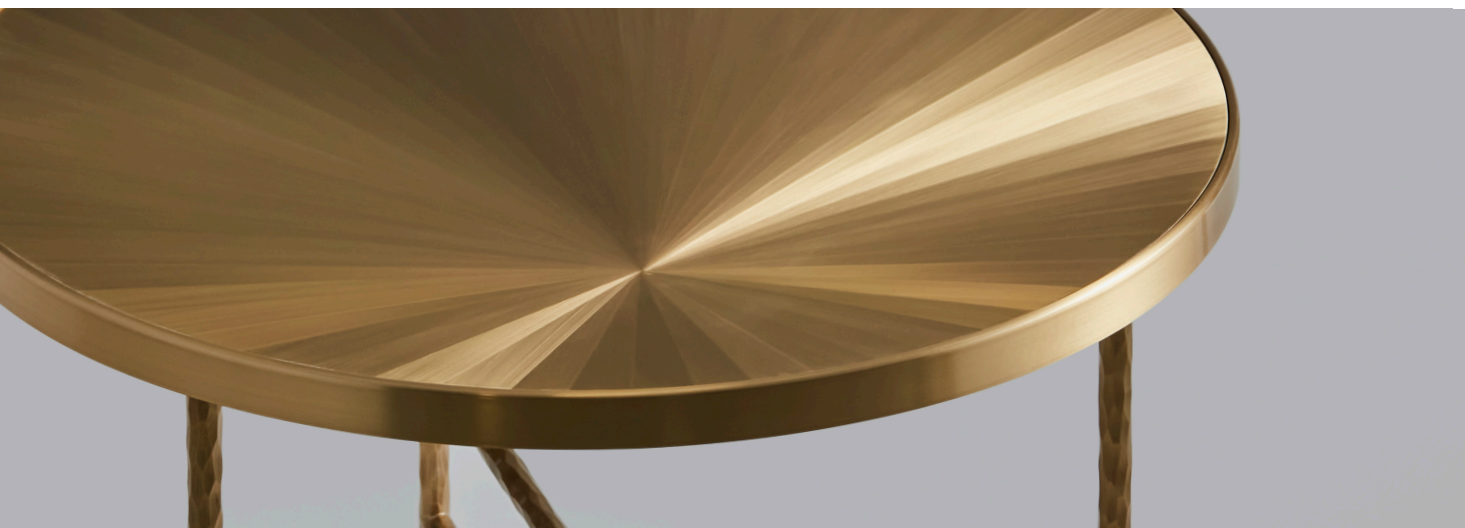

## ECLIPSE - COFFEE TABLE

### MATERIALS

Brass and glass

### FINISHES



Directional brushing - Glossy transparent varnish



Marbled

### DIMENSIONS & WEIGHT\*

Table S : H 480 x Ø550 mm, 30kg

Table M : H 550 x Ø550 mm, 30kg

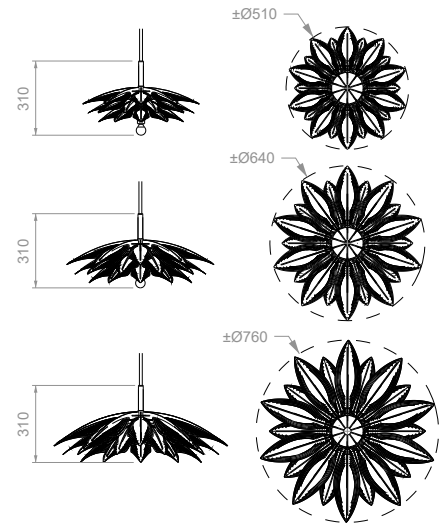







## DAHLIA

### MATERIALS

Brass

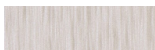
### FINISHES

|   |   |
|---|---|
|    | Polished pale gold                                |
|    | Polished white nickel                             |
|    | Polished black nickel                             |
|    | Directional brushing - Glossy transparent varnish |
|  | Brushed white nickel                              |
|  | Brushed black nickel                              |

### LIGHT SOURCE

Gold light bulb E14/220V or E12/110V,  
4 to 7 Watts, dimmable, class 1   
CE certification or US wired, all components are  
UL listed, UL Certification on request.

### DIMENSIONS & WEIGHT\*

S : H 310 x Ø510 mm, 10 kg  
M : H 310 x Ø640 mm, 11.5 kg  
L : H 310 x Ø760 mm, 13.5 kg

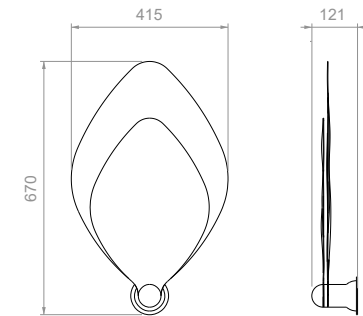
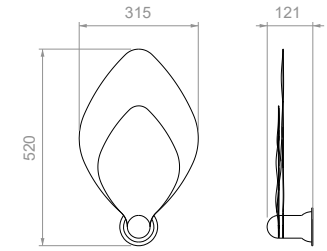

## FLAMME

---

### MATERIALS

Brass

### FINISHES



Polished pale gold



Polished white nickel



Polished black nickel

### LIGHT SOURCE

12V to 54V LED spotlights, 3 Watts - 350mA,  
dimable, class 3

Driver necessary

CE certification or US wired, all components are  
UL listed, UL Certification on request.



### DIMENSIONS & WEIGHT\*

S : H 520 x W 315 x L 121 mm, 2 kg

M : H 670 x W 415 x L 121 mm, 3 kg

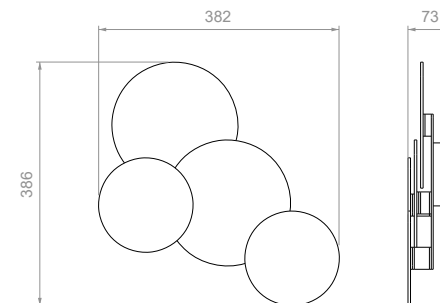
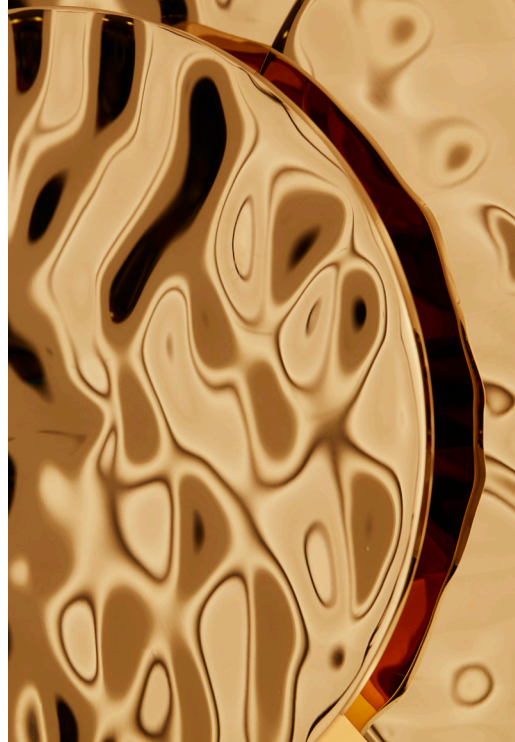
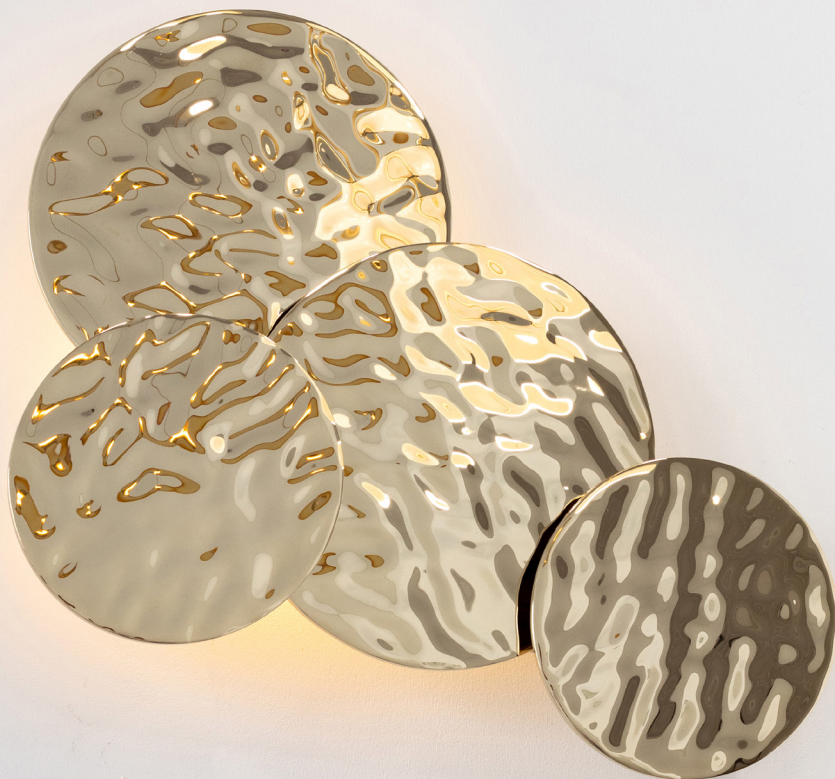



## LIQUIDE - WALL LAMP

### MATERIALS

Brass

### FINISHES

-  Polished pale gold
-  Polished white nickel
-  Polished black nickel

### LIGHT SOURCE

24V LED strip, 7 Watts, dimmable, class 3

Driver necessary

CE certification or US wired, all components are UL listed, UL Certification on request.



### DIMENSIONS & WEIGHT\*

H 386 x W 382 x D 73 mm, 6 kg

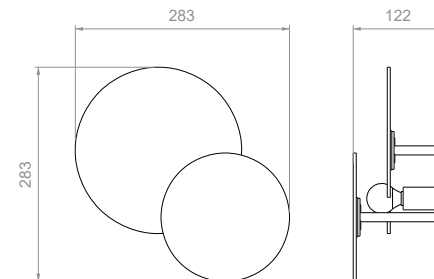
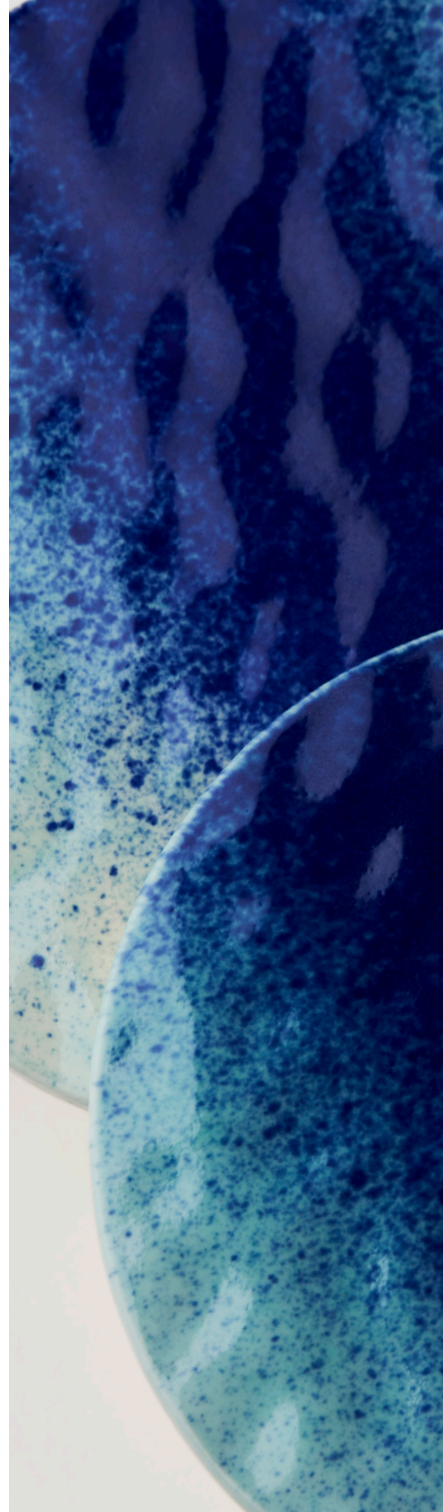
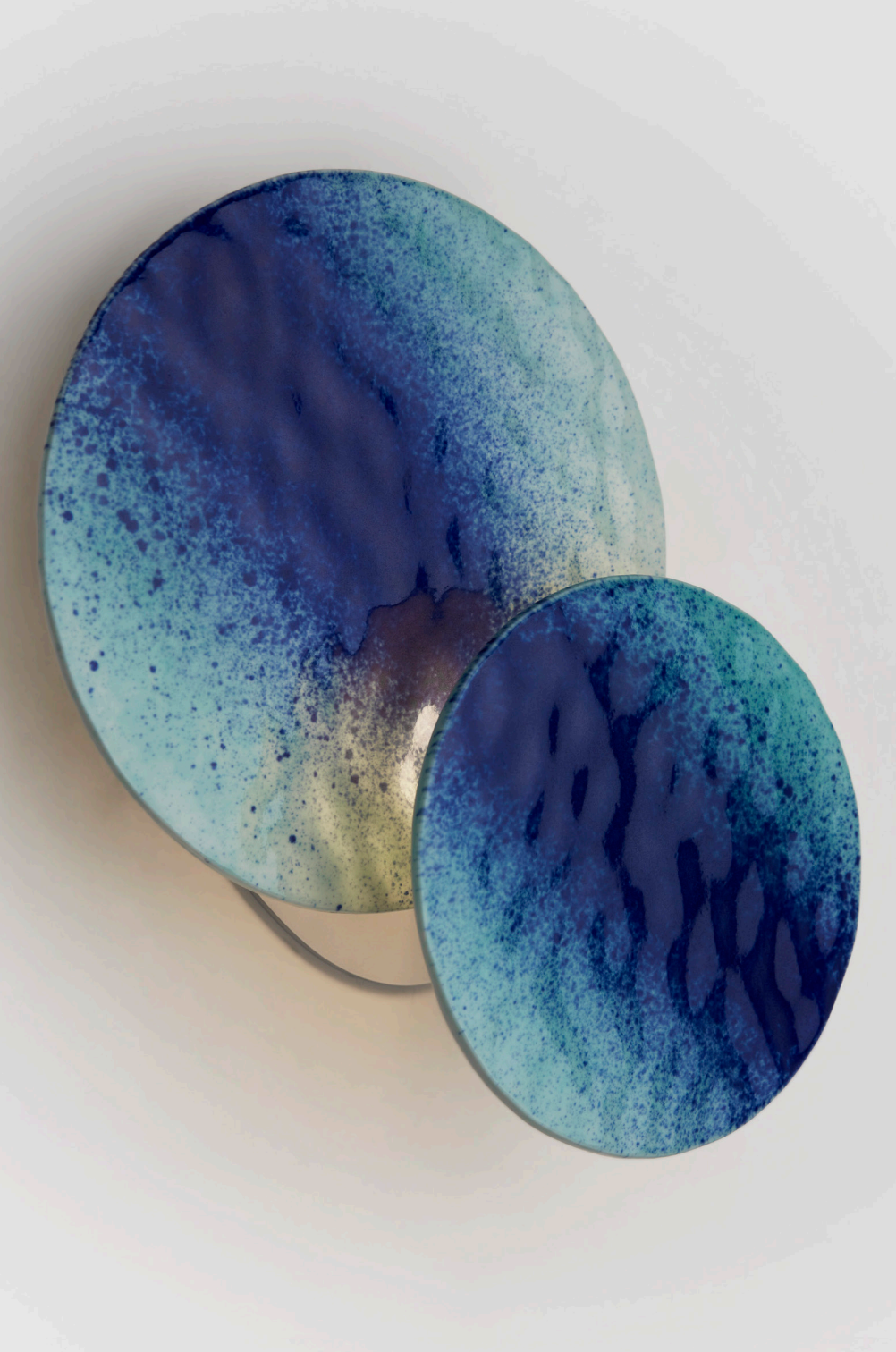

## LIQUIDE CÉRAMIQUE

### MATERIALS

Ceramic and brass

### FINISHES

 Glazed ceramic  
(various colors)

 Lacquered brass

### LIGHT SOURCE

Light bulb E14/220V or E12/110V,  
4 to 7 Watts, dimmable, class 1

CE certification or US wired, all components are  
UL listed, UL Certification on request.



### DIMENSIONS & WEIGHT\*

H 283 x W 283 x D 122 mm, 2 kg

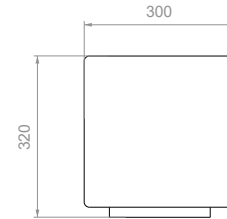

## LIQUIDE - SIDE TABLE

---

MATERIALS  
Brass

FINISHES

 Polished pale gold

DIMENSIONS & WEIGHT\*  
H 320 x W 300 x L 300 mm, 15 kg

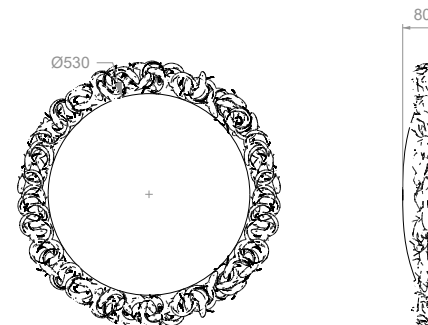

## MIROIR AUX CARPES

MATERIALS  
Brass

FINISHES

 Sand-blasted pale gold

 Polished brass with colored varnish  
(various colors)

DIMENSIONS & WEIGHT\*  
Ø530 x D 80 mm, 35 kg

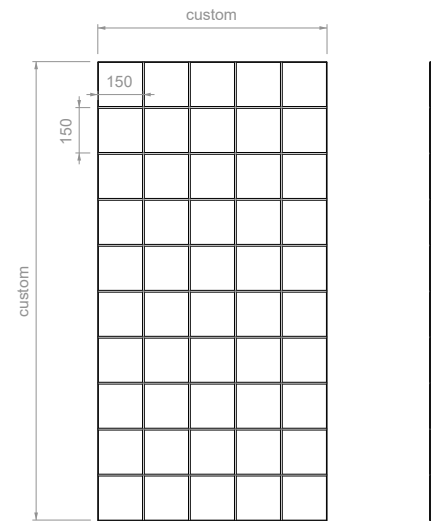
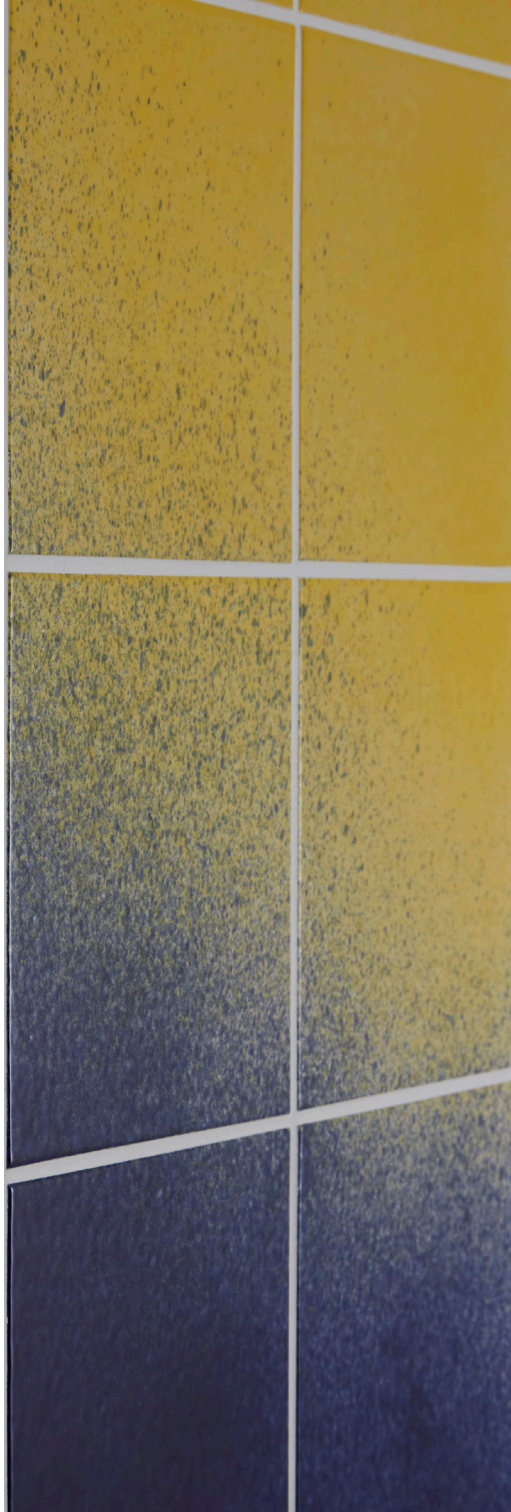
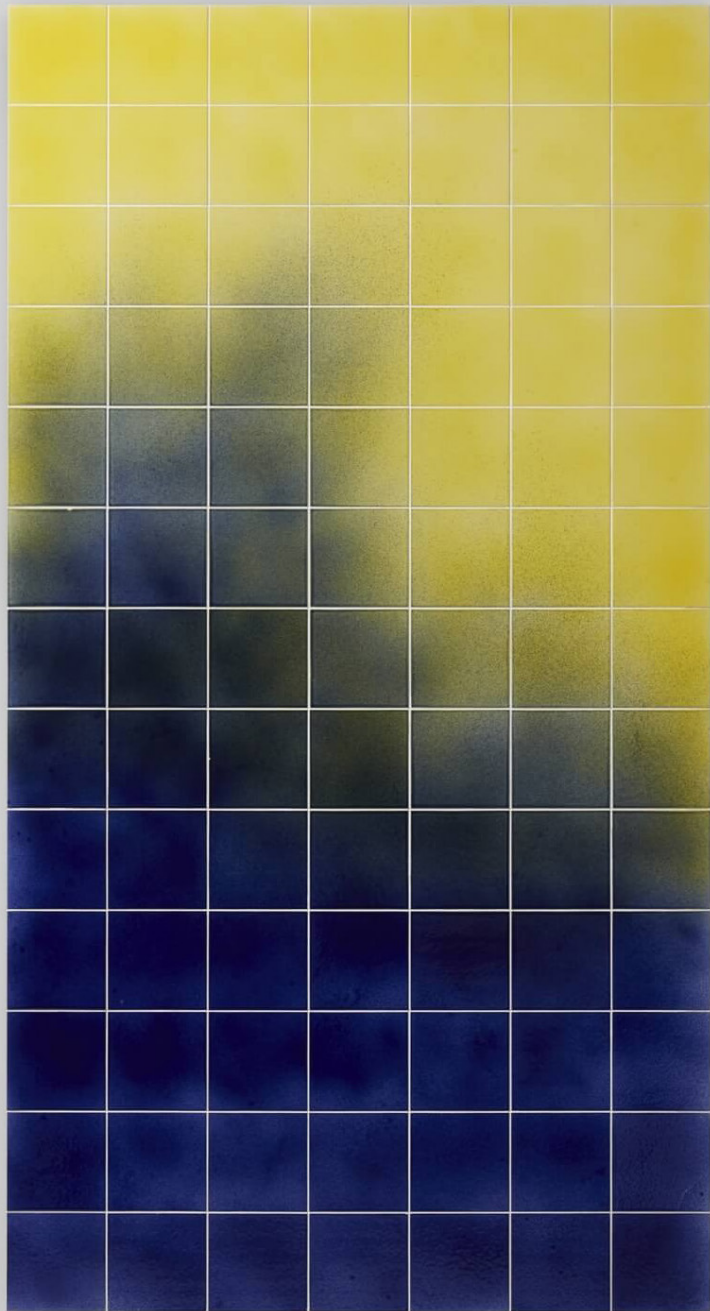

## IMPRESSION

---

MATERIALS  
Ceramics

FINISHES  
 Glazed ceramic  
(various colors)

DIMENSIONS & WEIGHT\*  
H 150 x W 150 mm each tile, custom





*Impression* tiles, *Arc* coffee table, *Merveilleux* stools,  
*Lumière Noire* rug, *Brume* pendants .

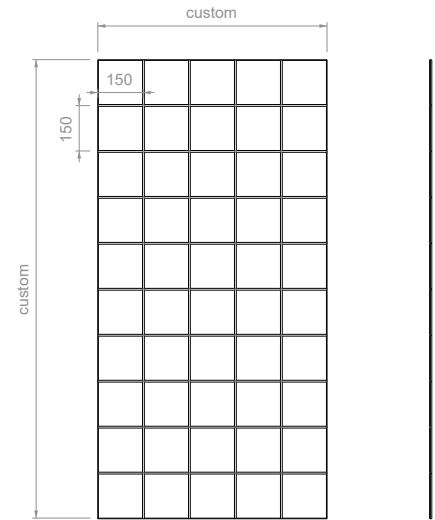
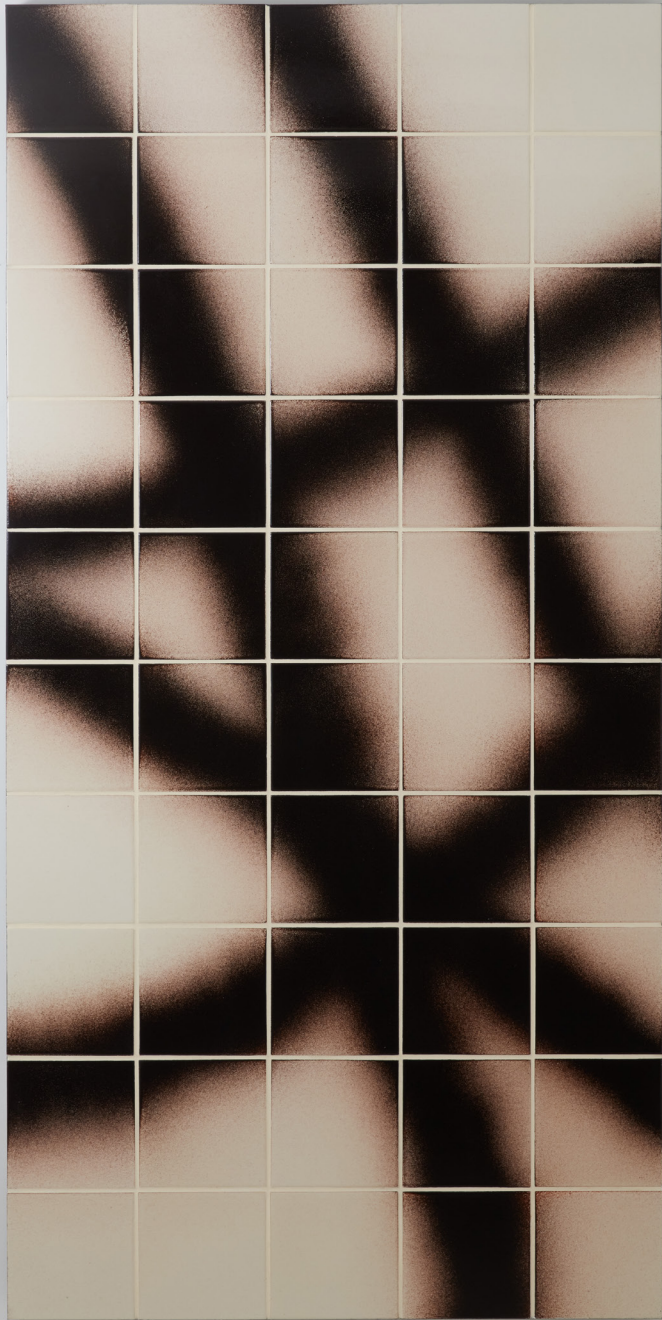

## TAG

---

MATERIALS  
Ceramics

FINISHES  
 Glazed ceramic  
(various colors)

DIMENSIONS & WEIGHT\*  
H 150 x W 150 mm each tile, custom

# MYDRIAZ

PARIS

[www.mydriaz-paris.com](http://www.mydriaz-paris.com)  
[info@mydriaz-paris.com](mailto:info@mydriaz-paris.com)  
© MYDRIAZ Catalogue 2024

Pictures by Jérémy Josselin and Bertrand Fompeyrine